



A guide to using 'Logicator for PIC micros' software and connecting to a PIC microcontroller

© Copyright Revolution Education Ltd. and New Media Learning Ltd 1999-2008.
PICAXE technology and portions of this document are © Copyright Revolution Education Ltd.
No part of this publication may be reproduced, stored in a retrieval system, or transmitted in
any form by any means, without prior permission of the copyright holder.
Copyright is waived in the following circumstances: small number of copies may be made for
use only in the purchaser's school.
These copies may not be sold or made available outside the purchaser's school.

Contents

Getting Started	3
RM CC3 Installation	3
Website.....	3
Support	3

Software

Overview.....	5
Index of Logicator commands	6
Installing the USB driver and cable.....	7
Memory Use	8
How to build, edit and test run a Logicator flowsheet	9
Commands.....	10
How to test run a flowsheet	12
Displaying and using BASIC.....	13
Outputs.....	15
Inputs.....	21
Digital Inputs.....	22
Analogue Inputs.....	27
Using Infrared control.....	29
Using Ultrasonic measurement	30
Procedures.....	31
Variables	37
Counting	37
Timing	40
Mathematical expressions.....	41
Simulations	44

Getting Started

Install the Logicator software onto the hard drive of your computer using your normal method for installing software.

See Section One for information on how to use the software.

See Section Two for information on connection to the PIC microcontroller chip.

It is necessary to install the Microsoft.NET framework prior to running the software.

The Microsoft.NET framework is included on the Logicator CD and will normally install automatically.

Please note that this version of Logicator is not compatible with Windows 95.

RM CC3 Installation

On the CD you will find instructions for installing Logicator on RM CC3 networks.

Because Logicator requires the .NET framework, it is necessary to allocate both the Logicator package and the .NET framework package to every workstation.

Website

The PICAXE website provides the latest Logicator news and information: www.picaxe.co.uk

The Logicator.net website has more general information about Logicator: www.logicator.net

Support

The Logicator user group on the www.picaxeforum.co.uk website contains most of the information that you will need in order to solve any technical issues. Once registered, you can post and contribute information to the group to help you and other users of the products gain help.

The Logicator help files contain frequently asked questions and solutions to common problems.

The help can be found by pressing F1 in the Logicator software or from the Help > Contents menu.

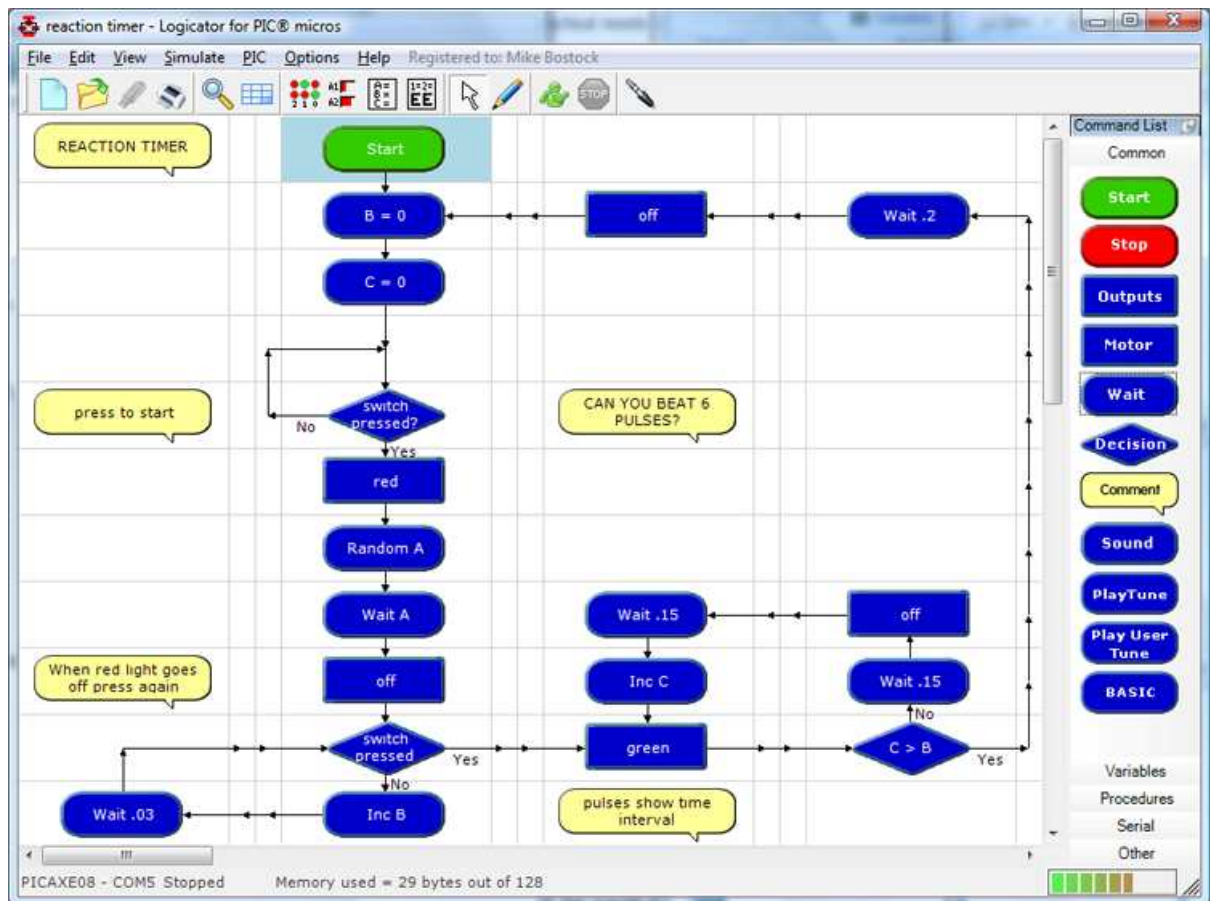

Section 1

Logicator for PIC Micros

Overview

Logicator provides a graphical environment for designing, testing, editing and downloading control sequences for PIC microcontrollers.

The range of Logicator commands allows the user to control output devices, such as motors and lamps that are connected to the PIC microcontroller. We can switch devices on or off in sequences using: timing, counting, repetition, and decisions based on signals from digital and analogue sensors that are connected to the PIC microcontroller.

This section of the book explains how the software is used, giving examples of the various commands and techniques in the context of possible school projects.

It is organised under the following headings:

1. How to build, edit and test run a Logicator flowsheet

2. Outputs

This section shows: how to switch output devices and motors connected to outputs of a PIC microcontroller, using *Outputs*, *Motor*, *SOUND* and *OUT* commands; how timing can be built into a control system using *Wait* or *Sleep* commands; how the *SerOut* command can be used to output serial information from the PIC microcontroller.

3. Inputs

This section shows: how to check the state of digital sensors connected to a PIC microcontroller using the *Decision* command; how to use the Interrupt command for instant response to digital sensors; how to use the *Compare* command to make use of readings from analogue sensors connected to a PIC microcontroller, in a control system.

4. Procedures

This section shows the important technique of building a control system as a number of linked sub systems.

5. Variables

This section shows: how to create counting systems using *Inc* and *Dec* commands; how timing can be built into a control system; how *Expression*, *IN* and *RND* commands are used to give a value to a variable; how *READ* and *WRITE* commands are used to store and access values of variables using the PIC microcontroller's EEPROM memory.

Quick Start

If you are unfamiliar with the Logicator approach to building control systems, it is a good idea to begin by familiarising yourself with the most commonly used commands, which are: *Outputs*, *Wait*, *Motor* and *Decision* (see the Index of Commands page 6). Build and test run the Examples, using section 1 ("How to build, edit and test run a Logicator flowsheet") as a reference to help.

Index of Logicator commands

Outputs	15
Outputs command	15
Wait command.....	15
Out Command.....	16
Sound Command.....	16
Motor command.....	16
Sleep command	17
SerOut Command.....	17
Sertxd Command	18
Servo Command.....	18
PulseOut Command	19
PlayTune Command	19
Play User Tune Command.....	20
PWM Command.....	20
Inputs	21
Digital Inputs	22
Decision command.....	22
Interrupt.....	25
Count Command	25
SerIn Command.....	25
PulseIn Command	26
Count Command	26
Analogue Inputs	27
ReadADC Command.....	27
Debug Command	27
ReadTemp Command	27
Compare Command	27
Using Infrared control.....	29
Infraln.....	29
InfraOut.....	29
Ultra	30
Procedures	31
How to build a procedure	31
How to use a procedure.....	31
Designing systems with procedures	34
Variables	37
Counting.....	37
The Inc command.....	37
The Dec command	38
Timing.....	40
Setting the value of a variable.	38
The Expression command	40
Mathematical Expressions	41
The IN command.....	41
The RND expression	41
Read and Write	42
Time	43
LCD	43
BASIC.....	43
Random.....	43

Installing the USB cable and driver

Plug the USB cable into a USB port.

Always use the same USB port because this will be the port allocated to this cable.

The computer will prompt for a USB cable driver.

Do not allow the Windows New Hardware Wizard to search the internet for a driver. Instead, specify the location of the driver by browsing to the AXE027 folder on the CD. Follow the on-screen messages to install the USB cable driver.

See the AXE027 USB cable setup guide for more details (from the 'Help' menu)

Selecting the PIC type

Launch the 'Logicator for PIC micros' software. Choose Options > Select PIC type...

Select the 'PICAXE-08' chip.

In 'Configure the I/O' select 'In - 3 O(0,1,2)'

This will provide inputs on bits 3 and 4 and outputs on bits 0,1 and 2.

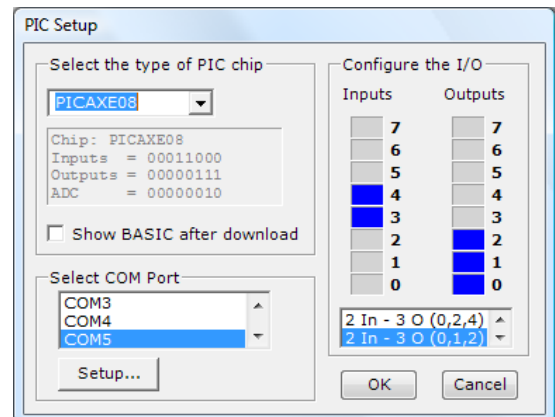

Selecting the COM number (port ID)

At the bottom of this dialogue window click 'Setup'.

In the Device Manager click 'Ports (COM and LPT)'. Click [+]. Note the COM number in the line that says 'AXE027...'. (in this case COM5)

Select this COM number in the 'Select COM port' dialogue in the 'PIC Setup' window

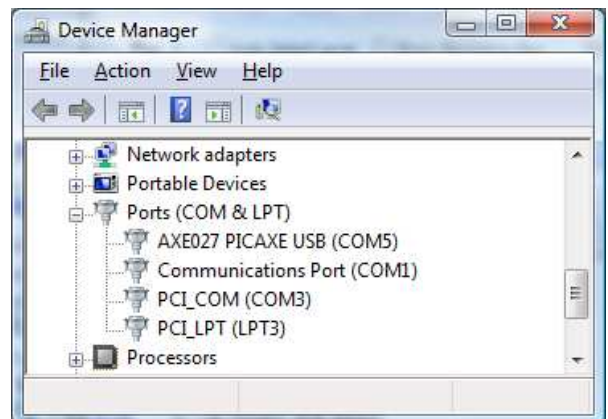

For 8 pin PICAXE devices, you must also configure the input/output options using the up/down selection box. Because 8 pin chips actually only have 5 pins that are available to use as inputs or outputs, these can be configured as such to suit your project. Pin 4 and Pin 7 are fixed as Input 3 and Output 0 respectively, but all other combinations are available.

Note that on the PICAXE08, the only analogue input is on Input 1, so if you wish to use analogue inputs with your PICAXE08 you must setup Input 1 to an input.

Note that on the PICAXE08, the only analogue input is on Input 1, so if you wish to use analogue inputs with your PICAXE08 you must setup Input 1 to an input.

When you select a chip, the software automatically configures itself to display only the input, output and motor options available with that chip.

Memory Use

The amount of memory available in the PIC chip you have chosen for your project is an important consideration when designing a flowsheet. Most commands use similar amounts of memory, but this does vary. Logicator provides two helpful tools to help you understand how much memory your flowsheet has used.

While you are designing a flowsheet, clicking PIC>Update Memory Use (ALT-F3) will recalculate an estimate of the percentage memory used by your flowsheet. This is displayed as a bar graph in the lower right corner of the Logicator window.

The bar fills with colour from left to right, for example:

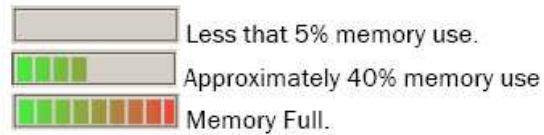

When using PICAXE type chips, the actual memory used after download is available, and is show on the status bar, below the flowsheet area in Logicator. Note that you must download your flowsheet into a PICAXE to get this information displayed.

1. How to build, edit and test run a Logicator flowsheet

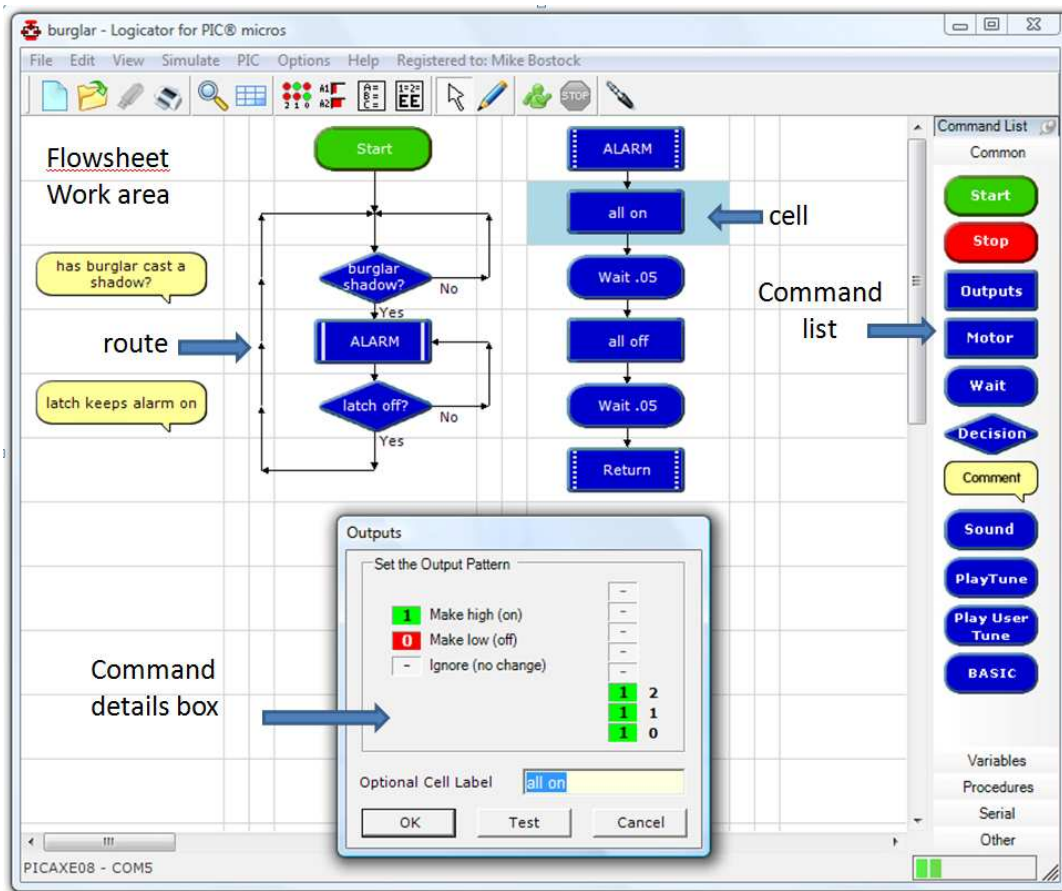

In Logicator, you create your control system in the form of a flowchart by dragging commands from the Command List and placing them in cells on the flowsheet working area (See above diagram). You can then click a command to open the commands' Cell Details boxes. Information about the command can then be entered. A route can be drawn from one command to another to show program flow. When the flowsheet runs, the flow of control follows the route you have drawn, carrying out the command in each cell as it passes through it.

Commands

NOTE: This chapter deals only with drawing the flowsheet. Details of how to use the various Logicator commands are given elsewhere in Section One. See the Index of commands at the beginning of this guide.

Creating a command cell

Drag the required command from the Commands List and place it on an unoccupied cell. Most commands have their own Cell Details dialog box which allows you to enter the command details. Double click on the command to open its Cell Details dialog box, and set the details of the command as required. When you have set the necessary details, click OK to close the dialog box.

START and STOP commands

These two commands do not have Cell Details dialog boxes. Simply place them on the flowsheet working area. A START command marks the point where the flowsheet starts running. When the PIC microcontroller is reset or powered up, the flowsheet starts at the START command. Every flowsheet must have a START command. A flowsheet will stop running whenever a STOP command is reached.

You can only use one Start and one Stop command in any flowsheet.

Labelling a command

It can be useful to give a command a label which identifies what it is used for, e.g. "switches on lamp". When you open a Cell Details box, the text in the yellow "label" box will be highlighted, so just type your label and click OK. This text does not affect the operation of a command; it is only a label.

Comment

Comment commands allow you to add short explanatory notes to a flowsheet. Although you can type up to 34 characters into the text box in the Cell Details box, the number of characters actually appearing in a Comment cell on the flowsheet will depend on factors such as the Zoom setting and screen setting.

The default screen setting shows up to 16 characters in a Comment cell. Comments have no effect on the operation of a flowsheet.



Explanatory information can be added to the flowsheet by using command labels and Comment commands.

Selecting a block of commands

Click on the top left corner of the block of cells. Hold down the Control Key (CTRL) and click on the lower right corner of the range of cells.

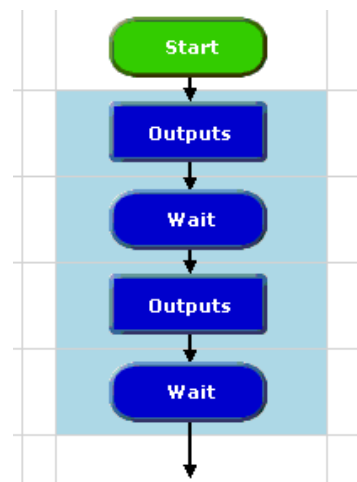

A block of commands in the selection frame

Selected commands are coloured light blue. To deselect commands, click on another part of the flowsheet.

Deleting a command

Click on the command to select it. Selected commands are coloured light blue. Press the Delete key to delete the selected command. To delete a block of commands, select the block and press the Delete key.

Moving commands

To move a single command or a block of commands, select the area and drag it to its new position.

Cutting, Copying and Pasting

Use the Cut, Copy and Paste options from the Edit menu to cut or copy selected commands or blocks of commands and paste them either into another part of the same flowsheet or into a different flowsheet. Alternatively, you can copy commands or blocks of commands within a flowsheet by first selecting them and then holding down the Ctrl key as you drag them to their new position. Remember that copied commands will retain their existing cell details.

Flowsheet working area

Cells are arranged in rows and columns. Each flowsheet has 22 columns and 25 rows. The default screen shows just 12 columns and 12 rows. Use the View>Zoom menu if you want to change the number of cells visible on the screen.

Map

The Map option allows you to view the whole of the flowsheet at once. The red square marks the area currently displayed on the screen.

Routes

Routes can be drawn through the middle of a cell, or in either one of the two rails between cells. Routes must be drawn in the direction that you want flow to take when the flowsheet runs.

Drawing Lines



Click on the Line Drawing icon on the toolbar to select drawing mode.

The mouse cursor changes to a pen icon. Click at a command cell where the line should start. Now move the pointer along the route you wish to draw. A dotted line will show where the route will be drawn. At a corner click again and continue moving the pointer until you reach the end of the desired route.

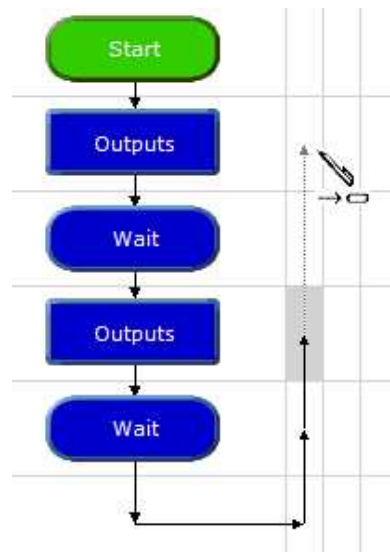

Routes can be drawn through cells or between rails.

Click to complete the route, then Right Click to end drawing mode.



Drawing mode can also be deselected by clicking the arrow icon.

Drawing mode can also be selected by right clicking a command and choosing Start Line from the submenu.

Lines can only be drawn vertically or horizontally. Always draw the line in the direction of the flow, as indicated by the arrows.

Hot tip

By holding down the Control key, the arrow keys can also be used to draw lines.

Deleting routes

Click at the beginning of the route to be deleted, and press the Delete key. When you draw a new route from a command, the existing route from the command will automatically be deleted. To delete a route without deleting the command in which it starts: first click on the command to select it. Then hold down the Ctrl key as you press the Delete key.

How to test run a flowsheet

Before you download a flowsheet to a PIC microcontroller, it is useful to be able to check that it works as you intend it to. Logicator has a number of features that allow you to test run the flowsheet in the software.

1. The Digital Panel

As a flowsheet runs, the Digital Panel shows the changing state of outputs, motors and inputs as they would be if the flowsheet had been downloaded to a PIC microcontroller. To display the Digital Panel, select the View>Digital Panel menu. Alternatively, click the toolbar icon shown below.

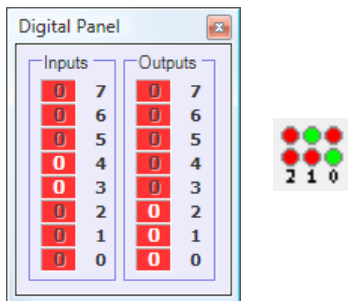

Digital Panel and its toolbar icon

2. Simulating digital inputs

The function keys on the computer keyboard are used to simulate inputs from digital sensors while a flowsheet is running.



Function keys F2 to F9 will simulate digital sensors connected to inputs 0 to 7 on a PIC microcontroller. Key F2 simulates input 0; key F9 simulates input 7.

Pressing the function key is equivalent to the sensor being “on” (1). When the key is not pressed, it is equivalent to the sensor being “off” (0).

Clicking on the corresponding input or output on the digital panel will also have the same effect.

3. Simulating analogue inputs

The Analogue Panel allows you to simulate the changing reading from analogue sensors while a flowsheet is running. Identify the

sensor (A0 to A3) which you wish to simulate, and use the slider in the panel to vary the simulated reading from 0 to 255.

To display the Analogue Panel, select the View>Analogue Panel menu. Alternatively, click the toolbar icon shown below.



Analogue Panel and its toolbar icon

4. Run and Stop



To test run a flowsheet, either click the green Run icon or click the Simulate >Run menu item.



To stop a flowsheet running, either click the Stop icon or the Simulate>Stop menu item.

As the flowsheet runs, the flow of control is highlighted so that you can follow it. If you want to slow down the speed at which flow is highlighted, select the Options>Set Simulation Run Speed... menu, and use the dialog box to adjust the speed.

5. Variables and EEPROM display windows

If your flowsheet uses variables, it is useful to display the Variables window when you test run it. The changing values of any of the variables A to H that are used in the flowsheet will be displayed as the flowsheet runs.

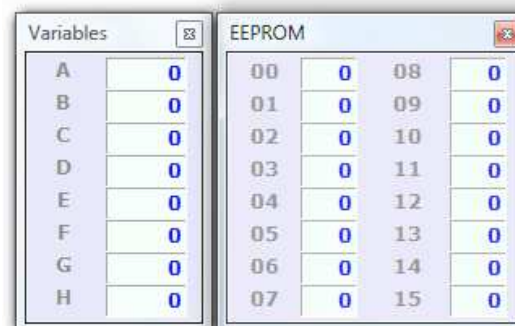

The Variables window and the EEPROM window

The EEPROM display window shows the value in each of the 16 addresses, when the flowsheet uses the READ and WRITE commands.

Displaying and using BASIC

Logicator is able to convert any complete flowsheet into BASIC.

BASIC is a text based language that is used throughout the world to program everything from PIC microcontrollers to Personal Computers.

Why Convert?

Logicator flowsheets are easy to understand and quick to build. BASIC programming languages offer more complexity to advanced level users and the ability to convert a flowsheet into BASIC offers a way of learning how BASIC programs are written.

Converting a flowsheet into BASIC

1. Design your flowsheet as normal and test the program using the flowsheet simulation tools provided in Logicator.

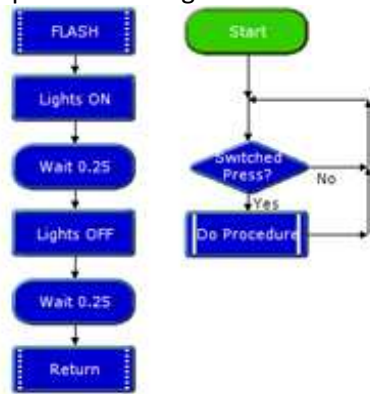

2. From the PIC menu, choose Convert flowsheet to BASIC.

3 The Flowsheet BASIC Conversion window is displayed containing the conversion of your flowsheet.

```
BASIC
Save Print Program PIC from BASIC
'EASIC converted from Logicator flowsheet:
'\\Edudevelopment\data\LOCK.PLF
'Converted on 21/9/2004 at 13:59:53

main:
    gosub prc_SET_CODE      'Do Procedure
label_58:
    gosub prc_CHECK_USER   'Do Procedure
    if b2 = 1 then label_60 'Compare command
    goto label_58

label_60:
    gosub prc_UNLOCK      'Do Procedure
    goto label_58

prc_UNLOCK:
    let pins = 255      ' %11111111
    pause 2000         'Wait command
    let pins = 0        ' %00000000
    let b2 = 0         'Expression command
    return             'End
```

Notes:

Only commands that are in the flow of your program are converted.

Code in the Flowsheet BASIC Conversion window can be edited and then re-programmed into the selected type of PIC.

Converting the Logicator flowsheet into BASIC always overwrites any changes made to the code inside the BASIC Conversion window.

It is not possible to convert from BASIC to a flowsheet.

You can use the mouse to select text in the code window. Right click on the selection to copy the selection to the clipboard. The code can then be pasted into software such as Revolution's Programming Editor.

Using the BASIC command in Logicator you can add sections of BASIC code into a flowsheet. Whilst this is not simulated in the Logicator software, you can make use of BASIC code that you might have available. See the Logicator help for full information on the BASIC command.

For full information on the use of BASIC to program PICAXE chips see the PICAXE website at www.picaxe.co.uk.

Downloading a flowsheet to a PICAXE chip

1. Connect your PICAXE project to the serial port of the computer by the download cable.
2. Connect power to the PICAXE circuit board.
3. Note; your PICAXE chip, if already programmed may start running the program from its memory – this will not affect the programming process.
4. Click the Program PIC button on the toolbar or PIC>Program PIC menu option.
5. The programming progress window will appear.

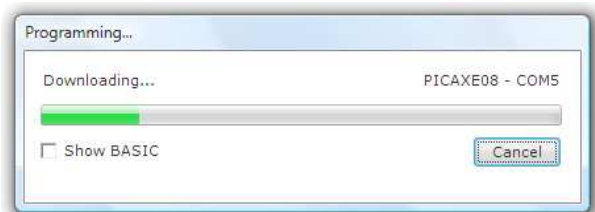

6. Programming times vary depending on the type of chip and amount of program code – the larger the flowsheet, the longer the programming time.
 7. If successful, programming is complete when the progress window disappears.
- Programming process window

2. Outputs

Outputs command

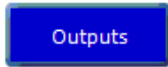

We can use an Outputs command to switch on or off any output devices that are connected to the outputs of a PIC microcontroller.

The "Output Pattern" line of its Cell Details box (below) shows the number of outputs available for use.

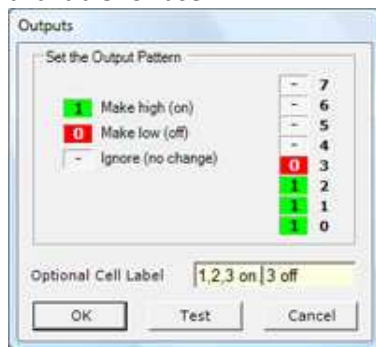

Outputs command Cell Details box

Each one of the digits in the Output Port represents one of the outputs on the PIC microcontroller. You can click each digit to set it to switch an output device on or off.

- 1** This means: switch this output on.
- 0** This means: switch this output off.
- This means: ignore this output, i.e. leave it in the state in which it was set by the previous Outputs command.

Wait command



A Wait command makes a running flowsheet pause for the number of seconds specified before the next command is carried out. You can use it to keep output devices switched on or off for a set time. Use its Cell Details box to enter a number of seconds (Max 65s. Min 0.001s) or a Variable.

Example

A PIC microcontroller has 3 LEDs connected to outputs 0, 1 and 2. The flowsheet shown top right will switch them progressively on and off

in a timed sequence. The sequence will begin as soon as the chip is powered and will stop at the STOP command - so it will do the sequence just once.

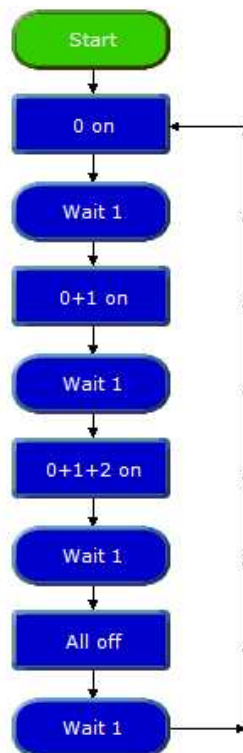
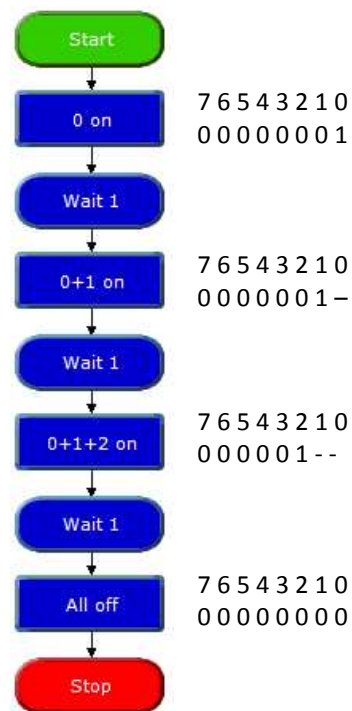

The flowchart shown left will continue to repeat the sequence until power to the chip is switched off. Notice that another Wait command has been added to the repeating sequence. The PIC microcontroller operates so quickly that, without Wait commands, the LEDs would switch on and off so quickly that you would not see it happening.

Out Command



When flow passes through an Out command, the output port is set to the binary value of the number entered in the command.

If you are familiar with the binary system then the Out command is a convenient way of switching combinations of outputs on or off.

bit	7	6	5	4	3	2	1	0
value	128	64	32	16	8	4	2	1

In the table above the 'bits' can be switched on by sending the selection value of the bit., e.g. 'Out 4', which will turn on an LED at bit 2.

Sound Command



Use a Sound command to send a pulsed signal to a piezo sounder connected to an output of a PIC microcontroller. You can use a sequence of sound commands to play a simple tune.

There are two ways to view the cell details for the Sound command. 'Simple' allows the setting of note, time and pin from drop down lists;



whereas the 'Advanced' option allows the selection of note via a 'keyboard' style layout .

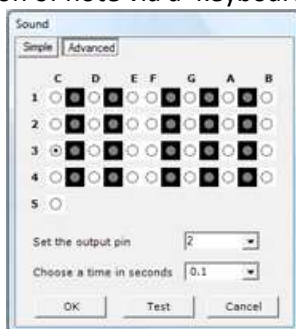

The notes used in Logicator are true sampled wav files, but the notes played by the PIC may vary due to the limitations of the pulsing of the piezo sounder.

Motor command

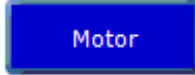

The Motor command allows you to use pairs of outputs on a PIC microcontroller to switch a motor forward, reverse or off.

Use its Cell Details box to set the motor or motors to drive forward or reverse; or to stop.

Remember that the direction in which a motor turns depends on which way current flows through it, and therefore on the way it is connected to power. For this reason, the direction arrows indicate only that the directions will be different; not the actual direction in which motors in the project will turn.

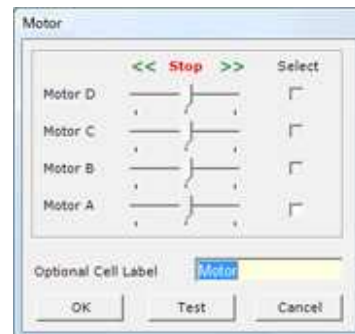

Motors are labelled A,B,C or D. Motor A is the motor controlled by outputs 0 and 1 of the PIC microcontroller. Motor B is the motor controlled by outputs 2 and 3, and so on. See "Connecting Motors"

NOTE: Outputs and Motor commands both use the same output lines to switch the outputs of a PIC microcontroller. The default state of both commands is such that they will automatically switch off any outputs that are not set 'on'.

So, to avoid inadvertently switching off an output device, un-check the select boxes of unused motors in a Motor command to disable them, and set unused outputs in a Outputs command to their 'ignore' state



Example

A steerable buggy is usually driven by two motors, one powering each driving wheel with a free-running jockey wheel to keep it stable. The flowsheet below shows how a sequence of Motor commands can be used to drive a buggy which has one motor connected to outputs 0 and 1 (motor A) and the other motor connected to outputs 2 and 3 (motor B).

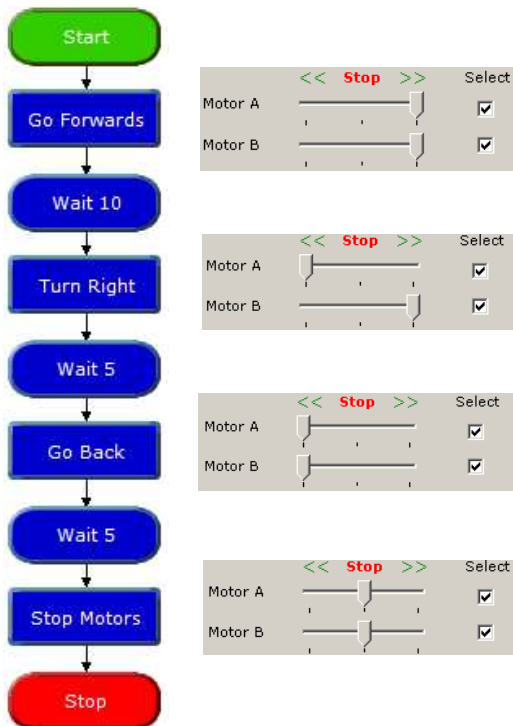

The Motor commands have been given labels to show what they do. The table beside each one shows how its Cell Details have been set.

Sleep command

Sleep

This command puts the PIC microcontroller into low power mode for a specified number of seconds.

This command can be used to save battery power in your project. All output devices will be left in their current condition, but signals from input devices will not be responded to while the chip is in sleep mode.

The Cell Details box is used to set the number of seconds of sleep mode required (this is in the form of number of multiples of 2.3 seconds). For example, a setting of 10 will sleep for 23 seconds.

Note that Sleep times are not as accurate as Wait times.

SerOut Command

SerOut

This command allows output information to be sent from the PIC microcontroller to a device such as a serial printer, a serial LCD screen or another PIC which is connected to an output of a PIC microcontroller.



The first box is used to select the output pin on the PIC microcontroller to send the data through.

In the Data box either type in the ASCII text you wish to send or raw data.

If sending raw data codes the ASCII box must be unchecked.

ASCII codes are useful for sending commands to LCD screens e.g. clearing the display.

Details of these control codes can normally be found with the instructions for the particular devices.

You can send a series of text characters e.g. "Hello" or a series of ASCII codes e.g. "254,1". In the latter case, ASCII codes must be separated by a comma.

If you wish to send the value held in a variable, type in the variable name in square brackets e.g. "[B]". Note you must use capital letters for the variable.

The last item to set is the serial mode. Set the mode to that specified by the device you are sending data to.

Example

The flowsheet shown below will display the word "Hello" on an LCD screen connected to output pin 2 of a PIC microcontroller.



A sequence to display the word 'Hello'

Sertxd Command

The sertxd command is similar to the serout command, but acts via the serial output pin rather than a general output pin. This allows data to be sent back to the computer via the programming cable. This can be useful whilst debugging.

See the PicAxe Manual for more information

Servo Command

Servos, as commonly found in radio control toys, are a very accurate motor/gearbox assembly that can be repeatedly moved to the same position due to their internal position sensor. Generally servos require a pulse of 0.75 to 2.25ms every 20ms, and this pulse must be constantly repeated every 20ms. Once the pulse is lost the servo will lose its position.

The Servo command starts a pin pulsing high for length of time pulse (x0.01 ms) every 20ms.

This command is different to all other commands in that the pulsing mode continues until another servo command or outputs command. Outputs commands stop the pulsing immediately. Servo commands adjust the pulse length to the new pulse value, hence moving the servo.

The cell details for the servo command have two settings; the output pin that the servo motor is connected to and the pulse time. The pulse time can be a value held in a Variable. Note that the value for the pulse time MUST be in the range 75 to 225. The servo motor may malfunction if the pulse is outside of this range.

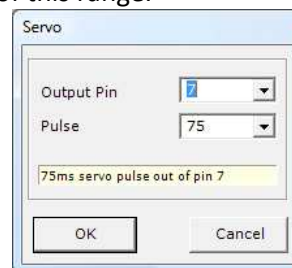

Servo command cell details

Example

The flowsheet below will move a servo motor attached to output 0 from one extent of its travel to the other, repeating continually.

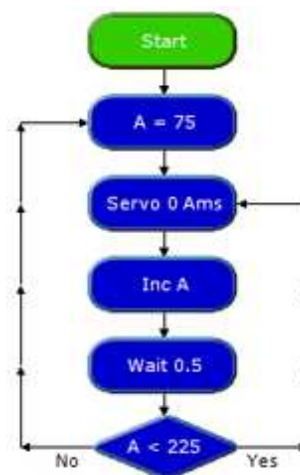

Using the Servo command

PulseOut Command



The PulseOut command generates a pulse through the chosen output. If the output is initially off, the pulse will be on, and vice versa.

There are two items to set in the cell details box for the PulseOut command below; the output pin to send the pulse through, and the length of time that the pulse should operate for.

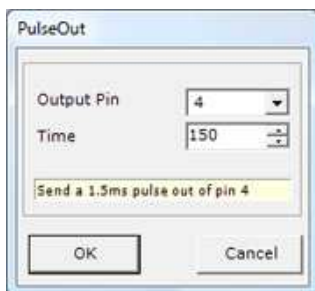

The time is in 10ms intervals, but for easier reading, the text area in the command converts this to milliseconds as the time is entered into the command. PulseOut times must be in the range 1 – 65535. Note that Logicator cannot simulate the action of the PulseOut command.

Example
The flowsheet below sends a pulse of 15ms out of output pin 4 every half second.

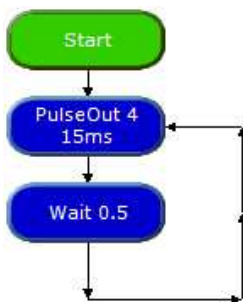

Using the PulseOut command

PlayTune command



The following PICAXE chips can play musical tones: 08M, 14M, 20M, 28X1, 40X1. These have 4 pre-programmed internal tunes, which can be output via the PlayTune command.

As these tunes are included within the PICAXE bootstrap code, they use very little program memory.

The cell details require that the number of the tune is set and if you wish the outputs to flash in time to the tune.

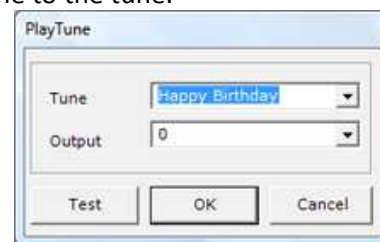

The Tunes are:

- 0 - Happy Birthday
- 1 - Jingle Bells
- 2 - Silent Night
- 3 - Rudolf the Red Nosed Reindeer

The Flash modes are:

- 0 - No outputs
- 1 - Output 0 flashes on and off
- 2 - Output 4 flashes on and off
- 3 - Output 0 and 4 flash alternately

The following example will play Happy Birthday while flashing output 4.



Logicator cannot accurately simulate the flashing actions of the PlayTune command.

It is possible within the Programming Editor software available from Revolution Education, to program your own tune into a these types of PICAXE chip.

Play User Tune Command



Working in a similar way to the PlayTune command, the Play User Tune allows special musical tunes to be played.

The difference with the Play User Tune command is that it converts RTTTL mobile phone ringtone files to PICAXE tunes and plays them with or without flashing outputs.

RTTTL ringtone files are freely available on the internet (there is a very wide range of tunes available) and these can be downloaded as small text files. The files contain the notes and timings that make up the tune. Logicator converts these ringtones to a PICAXE tune upon download.

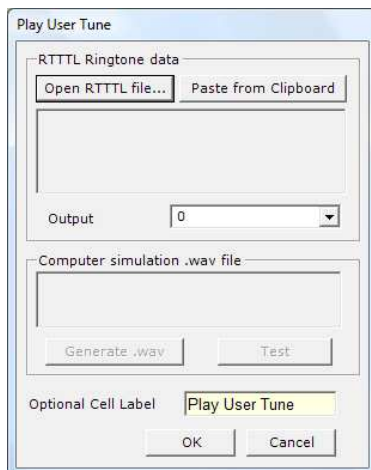

Play User Tune dialog box

Once you have downloaded your ringtone file (ensure it is an RTTTL format), save it to disk and open the cell details box for the Play User Tune command.

Click the 'Select Ringtone...' button to browse the computer to find the file.

Select the output to flash using the drop down box. The chosen outputs switch on/off in time to the tune. The Flash Mode can switch outputs 0 and 4. Ensure that you have configured the I/O pin 4 as an output using the Select PIC dialog in order to see all of the available options.

In order to use the ringtone in a simulation you must click the 'Generate .wav' button. Finally, choose the OK button.

Note that, unlike the PlayTune Command, the User Tune requires much more memory in the chip as all of the notes have to be specially programmed into the chip. If you wish to play your tune a number of times, use the Play User Tune command in a Procedure to save memory.

PWM Command

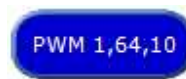

The PWM command is used to provide 'bursts' of PWM output to generate a pseudo analogue output on the PICAXE-08/08M (pins 1, 2, 4). This is achieved with a resistor connected to a capacitor connected to ground; the resistor-capacitor junction being the analogue output. PWM should be executed periodically to update/refresh the analogue voltage.

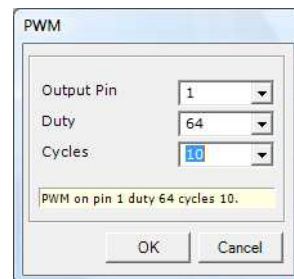

PWM dialog window

The parameters are: the Output pin used, the analogue level 0-255 (Duty) and the number of 5ms cycles that specifies the duration.

3. Inputs

Input devices such as switches and sensors send information from the outside world into the control system. Output devices are switched on or off in response to the information provided by input devices.

Example

A buggy is often fitted with micro-switches so that if it approaches an obstacle, a microswitch will be pressed.

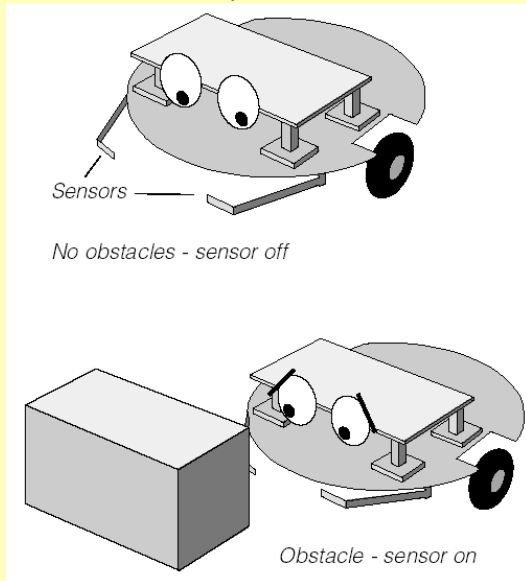

The information that the switch has been pressed can be used in the system to switch off the motors driving the buggy, and start a sequence of movements to move around the obstacle.

A microswitch is a digital sensor. It has only two states - "on" (or "closed") and "off" (or "open").

These states are often labelled by the digits 1 and 0, which is why the sensors are called digital sensors.

Example

A controlled hot water system includes a temperature sensor which constantly monitors the water temperature.

The water heater is switched on and off in response to the information provided by the sensor. If the water temperature falls below a set level, the heater is switched on until it reaches that level again. Then the heater is switched off.

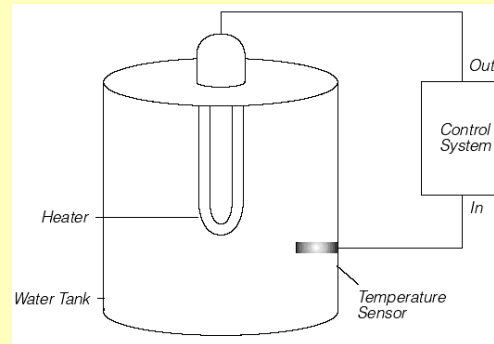

A temperature sensor is an analogue sensor. It provides a reading which changes in line with the changing level of whatever it is sensing.

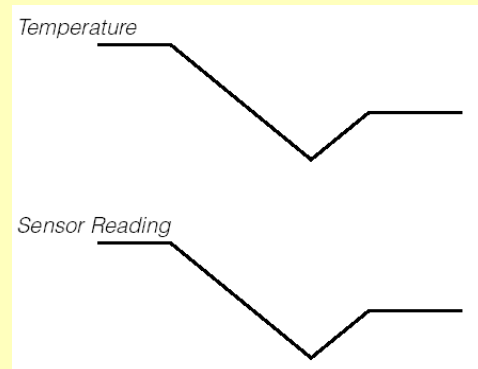

Digital Inputs

Decision command

Use this command to test the state of a digital sensor connected to a digital input of a PIC microcontroller.

When flow reaches a Decision cell, it continues in either the Yes or No direction depending on the result of the decision test.



This Decision command is testing the state of a microswitch. If the switch is pressed, flow will go in the Yes route; if it is not pressed, flow will go in the No route.

The Cell Details box of the Decision command is shown below. The Input Pattern area shows the number of digital inputs available for use on the PIC microcontroller you have selected. Any unavailable inputs are shown without a number label and cannot be clicked upon.

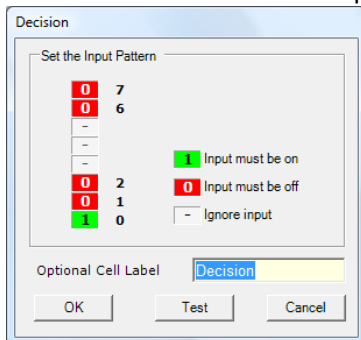

Decision Cell Details box for a PICAXE18X chip (five inputs).

Each one of the digits in the Input Port represents one of the digital inputs on the PIC microcontroller. You can click each digit to set it to one of three states:

- 1 This means is this sensor ON?
- 0 This means is this sensor OFF?
- This means ignore this sensor.

Drawing routes from a Decision command

The first line that you draw from a Decision command is the “Yes” direction, and the second line is the “No” direction.

Tip; you can swap the “Yes” and “No” routes by right clicking on the Decision and choosing “Swap Yes/No”.

Example

A PIC microcontroller is being used to control a security system. A buzzer is connected to one of the outputs. A pressure pad is connected to input 0, and a push switch is connected to input 1.

Below is a flowsheet for the control system, showing how the two Decision commands are set. When the chip is powered, the pressure pad is tested. If it is not pressed, flow will go in the N route and will continue to go round this loop until the pad is pressed. When the pad is pressed, flow will go in the Yes route and the buzzer will be switched on. The buzzer will stay on until the push switch is pressed. When it is pressed, the buzzer will switch off and flow will return to testing the pressure pad.

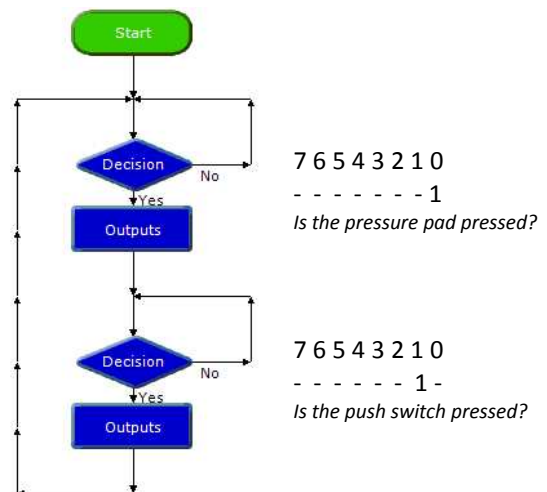

Security system

A similar flowsheet could be used to control a security system for a drawer. In this case, the sensor could be a micro-switch which is kept

closed (on) as long as the drawer is shut. If someone opens the drawer, the microswitch will be open (off). The flowsheets below shows two different ways of using a Decision command to test the micro-switch in this system.

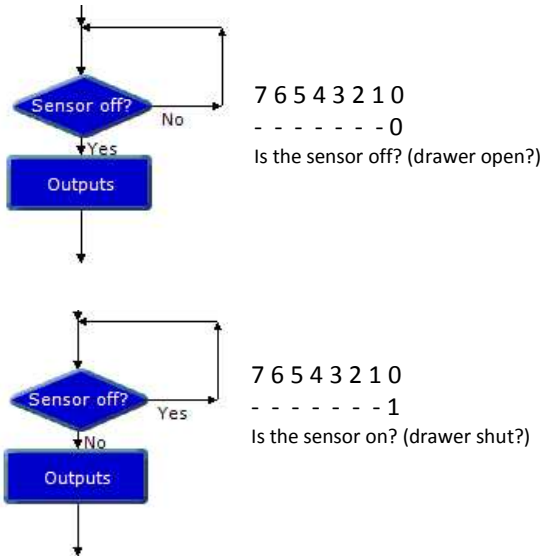

Notice that the direction of flow depends on how the command is set.

Example

Home security systems often have a number of sensors in different parts of the house. If any one of them is activated, the alarm is switched on. The flowsheet below shows a security system which has three sensors and a reset switch.

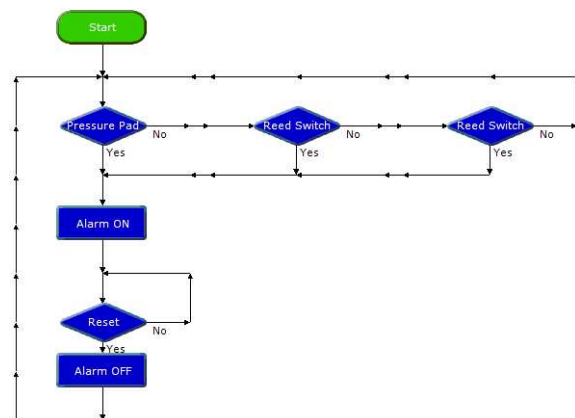

Security system with three sensors (OR function).

Two of the sensors are the magnetic type for windows which have the magnet fixed to the window frame and the reed switch fixed to

the window. As long as the window is shut, the magnet keeps the reed switch contacts closed ("sensor on"). When the window is opened and the magnet is moved away from the switch, the contacts are open ("sensor off"). Therefore, the two Decision commands have been set to go in the Yes route if the sensor is off (0).

The system shown is an OR function. Some security systems have two separate reset switches arranged in an AND function so that the system is reset only if both switches are pressed together. The flowsheet below shows how you can set a Decision command to test two switches in this way.

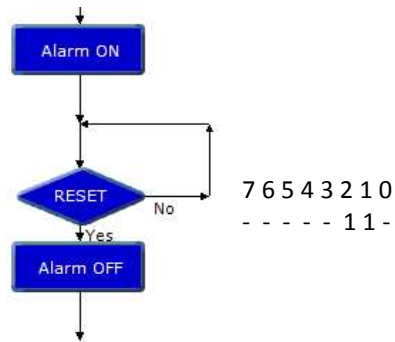

Decision command set to check if two switches are pressed at the same time (AND function).

Example

In the flowsheet shown below, the output is switched on when a push switch is pressed. When you stop pressing the switch the output switches off. In other words: IF the input is on, THEN switch the output on, ELSE switch the output off.

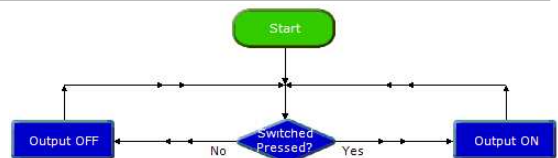

"Normally open" switch effect.

This is the equivalent of a simple electrical circuit containing a normally open push switch and an output device.

The difference is that you can change the way the system works in software, by simply changing over the Yes and No on the Decision command :

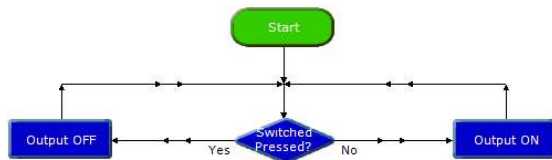

"Normally closed" switch effect.

Example

A mono-stable device has only one stable state. It changes state when it is triggered by an input, and stays in that state for a certain time. It then goes back to its original state. The flowsheet below shows how this function can be produced in Logicator.

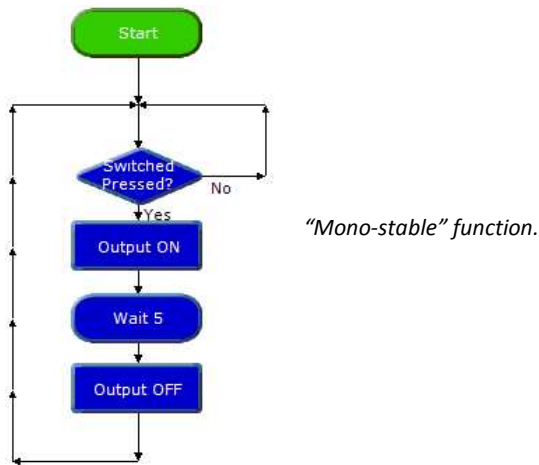

"Mono-stable" function.

Example

A bi-stable device has two stable states. It changes state when it is triggered (set) by an input, and stays in that state until it is triggered (reset) by a second input. It then goes back to its original state. The flowsheet below shows how this function can be produced in Logicator.

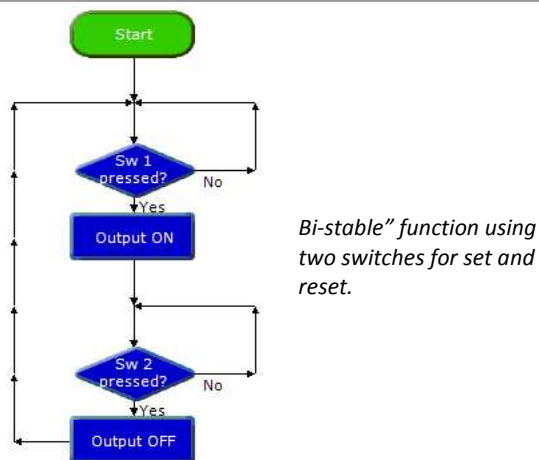

"Bi-stable" function using two switches for set and reset.

The flowsheet below shows how you can use just one switch for both set and reset. In this case the Decision commands are used in pairs.

The first one checks to see if the switch is pressed, and the second one checks for it to be un-pressed before the output is switched. The program is processed so fast that, if you didn't include this feature, it would switch the output and start checking the switch again while you were still pressing it for the first time.

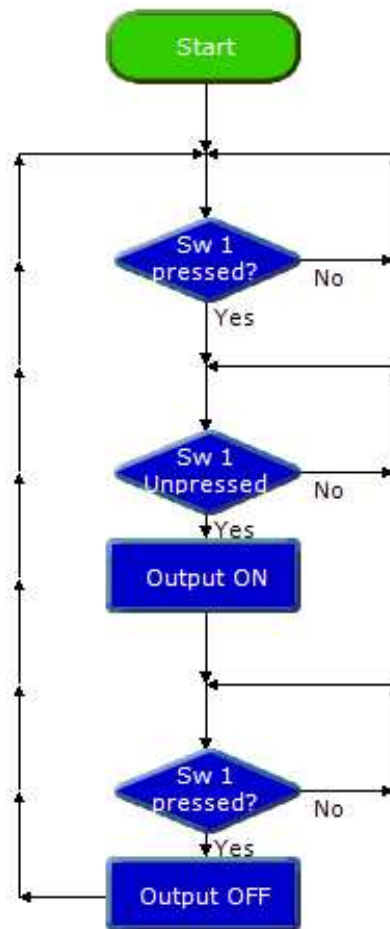

"Bi-stable" function using one switch for both set and reset

Interrupt



An Interrupt instantly captures the flow of control whenever a preset digital input condition occurs to trigger it e.g. when a switch is pressed.

When the interrupt is triggered flow jumps immediately to the Interrupt command and then carries out any commands which follow until it reaches a Return command. It then returns to the point which it was at when the Interrupt occurred.

In order to use an Interrupt, the PIC must be told to look for the input condition. This is done through the Interrupt Setup command. There are two options in the command – Enable or Disable.

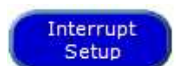

To prevent the Interrupt retriggering itself, the Interrupt is automatically disabled once it is triggered. To re-enable it another Interrupt Setup command is required.

Example

A PIC microcontroller running a continuous loop flashing lights needs to be able to react to a button press and play a warning sound.

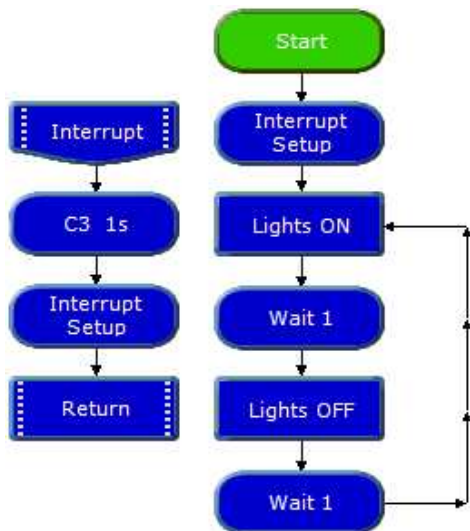

The Interrupt is used to capture the flow and play a sound. The interrupt is then enabled once again before returning to the point at which it left the main flow.

Note that the Interrupt MUST have an associated Return command and will not be triggered again until this Return command has been reached. There is no limit to the number of commands between the Interrupt and the Return.

Only one Interrupt can be used per flowsheet.

SerIn Command



The SerIn command is used to receive serial data into an input pin of the microcontroller. It cannot be used with the serial download input pin, which is reserved for program downloads only.

The cell details box for the SerIn command has three boxes to set.

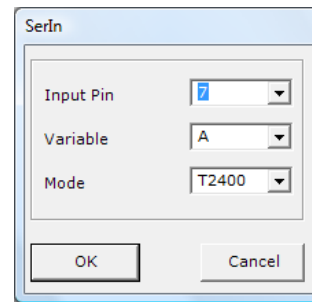

SerIn command cell details box

The input pin is the input on the PICAXE that the data is to be received through. The Variable option is a variable location that the data is stored into once it is received.

Lastly, the mode option specifies the baud rate and polarity of the signal. When using simple resistor interface, use N (inverted) signals. When using a MAX232 type interface use T (true) signals. The protocol is fixed at N,8,1 (no parity, 8 data bits, 1 stop bit). For best results do not use a baud rate higher than 2400 on 4Mhz chips.

The SerIn command forces the PICAXE chip to wait until serial data is received through the chosen input. This data is stored in the chosen variable.

Example

Serial data is being received from another PIC chip and needs to be stored in the EEPROM. In the flowsheet shown below, the serial data is read into Variable A through input pin2. The Write command is used to store the value in Variable A in the EEPROM. This process is repeated 16 times to fill all the available EEPROM memory locations

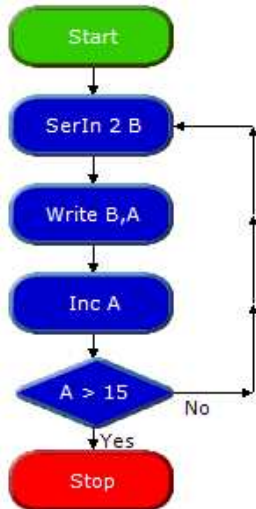

Using the SerIn command to receive serial data

PulseIn Command

`PulseIn ,1,A`

The PulseIn command measures the length of a pulse through an input pin. If no pulse occurs within the timeout period, the result will be 0.

If State = 1 then a low to high transition starts the timing, if state = 0 a high to low transition starts the timing.

There are three items to set in the PulseIn command; the input pin, the State and the Variable to store the result in. The result is measured in multiples of 10ms and is in the range 1 – 255.

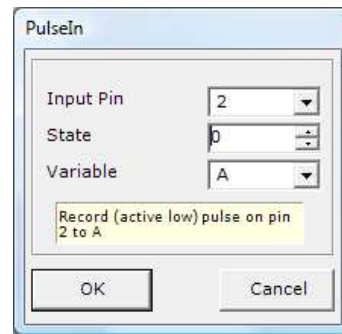

The cell details box for the PulseIn command

Use the Count command to count the number of pulses with a specified time period.

Because the PulseIn Command works so quickly this command cannot be simulated in the Logicator software.

Count Command

`Count 0,500,A`

The Count command is available on the PICAXE08M, 18X and 28X. The Count command checks the state of the input pin and counts the number of low to high transitions within the time 'period'. Up to 255 transitions can be counted.

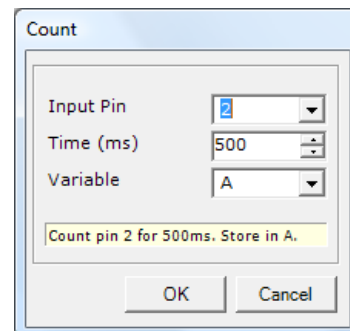

The cell details box for the Count command

Take care with mechanical switches, which usually cause multiple 'hits' for each switch push as the metal contacts 'bounce' upon closure.

Analogue Inputs

ReadADC

ReadADC 1,A

This command is used to read an analogue value from an analogue channel and assign the value to a variable. It is equivalent to using an Expression to set a variable equivalent to an analogue channel, as in the expression: A = A1.

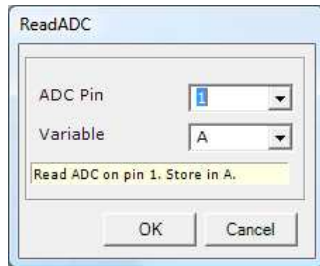

Debug

Debug

To read analogue values 'live' from a PIC chip we can use the Debug command in a loop like in the flowchart below.

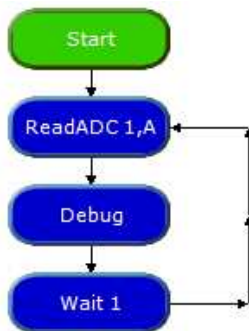

We then open the Debug window from the Menu PIC > Debug. When we download the above flowsheet into the PIC chip we need to keep the lead connected to the PIC chip in order for the analogue values to be read and displayed in the Debug window.

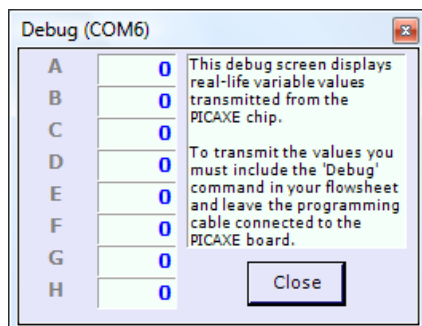

ReadTemp

ReadTemp 0,A

This command is used to read an analogue value from a D18B20 temperature sensor.

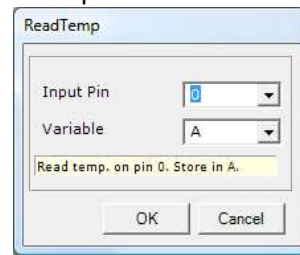

Compare command

Compare

This command can be used to check the reading from an analogue sensor connected to an analogue input of a PIC microcontroller. The most common use of an analogue sensor in a control system is to switch output devices on or off when the reading from the sensor reaches a particular level. This level is sometimes called the "threshold". When flow reaches a Compare cell, the software checks the current reading from the specified sensor, and compares it with the threshold that you have set. Flow will continue in either the "Yes" or "No" direction depending on the result of the comparison.

The Cell Details box of the Compare command is shown below.

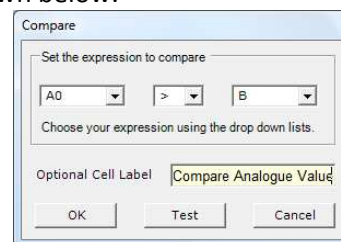

Cell Details box of the Compare command

1. Use box one to select the sensor that you want the command to check.

Analogue sensors are labelled A0 to A3 according to which pin on the chip they are connected to. Type in the number of the sensor you want the command to check, or select it from the drop-down box.

2. Use boxes two and three to complete the comparison. The drop-down list in box two contains a list of operators such as "greater

than" (>), "less than" (<), and "equals" (=). Select the one that you require. NOTE: It is usually better to use an operator such as "greater than or equals" (>=) instead of "equals", because analogue sensor readings can fluctuate rapidly, and you may find that the checking of the sensor reading never actually coincides with the exact threshold level.

3. Use box three to set the threshold level. Type in a number between 0 and 255, or select it from the drop-down list.

Example one

A PIC microcontroller is being used to control a lamp. A light sensor is connected to analogue input 0. The system will switch on the lamp automatically in dark conditions. Below is a flowsheet for the system.

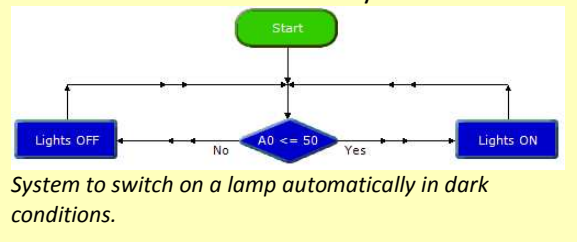

System to switch on a lamp automatically in dark conditions.

The Compare command checks the reading from the light sensor. If the reading is less than or equal to 50, flow will go to the Yes route and switch on the lamp; if the reading is greater than 50, flow will go in the No route and switch off the lamp. The system could be extended as shown below. This system controls three separate lamps, which it switches on one by one as darkness falls.

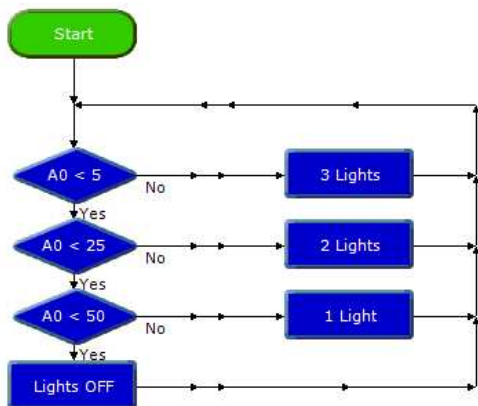

System to switch on three lamps in response to changing light levels.

Example

A PIC microcontroller is used to make a light meter for use by cricket or tennis umpires to decide when to abandon play because of bad light. A light sensor is connected to analogue input 0. An LED is connected to each one of the eight outputs. In bright sunlight, all the LEDs will be lit. As the light level falls, the LEDs will switch off one by one.

Below is the flowsheet for the system. Notice the use of the Out command to switch on combinations of outputs.

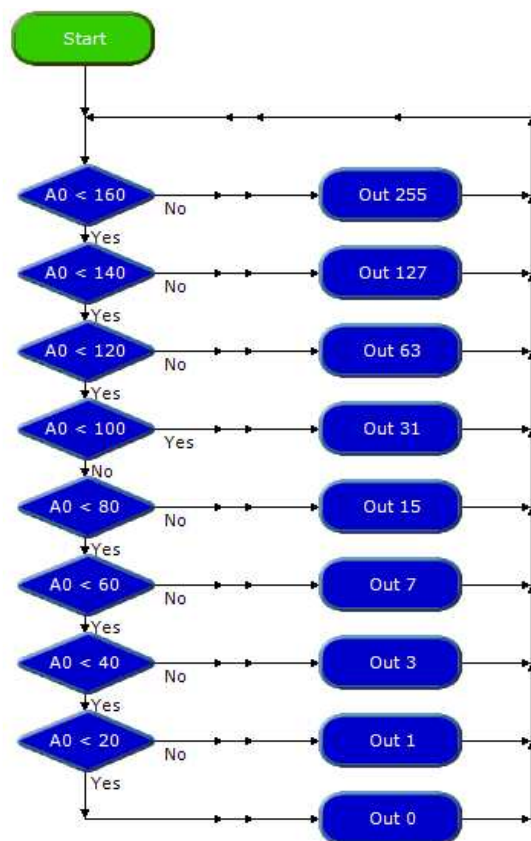

Light meter system

Using Infrared control

When using PICAXE chips, commands are available to support Infrared communication between PICs and TV style remote controls.

Infraln

Infraln To receive information from an Infrared source, the Infraln command is used. The command will wait for a new infrared signal from an infrared TV style transmitter. It can also be used to receive an InfraOut signal from a separate PICAXE chip.

All processing stops until the new command is received. The value of the command received is placed in the chosen Variable.

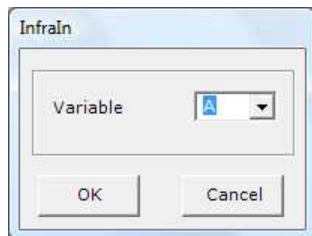

The cell details are simple; only a Variable must be set.

The basic circuit required for Infraln is as follows. The device on the left side of the circuit is an IR receiver LED, part code LED020.

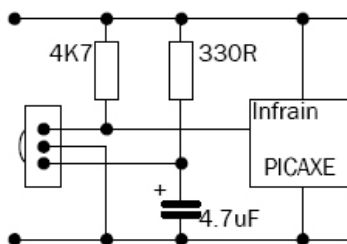

Example

In the following flowsheet a signal is received from a TV Infrared remote control. Lights are switched on if key 1 is pressed.

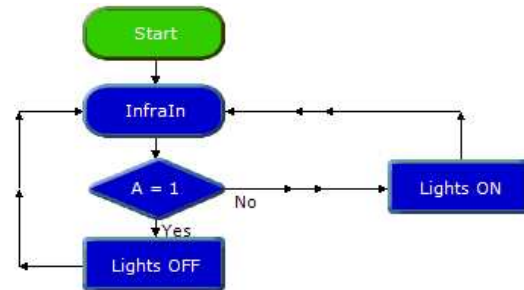

The Infraln command waits until a signal is received, and saves this as a number in Variable A.

The Compare determines if this is '1' and the Yes route switches on the lights.

InfraOut

InfraOut This command is used to transmit the infrared data to a Sony™ protocol device. It can also be used to transmit data to another PICAXE circuit that is using the Infraln command.

Data is transmitted via an infra-red LED (connected on output 0) using the SIRC (Sony Infra Red Control) protocol.

When using this command to transmit data to another PICAXE chip the Device ID used must be value 1 (TV).

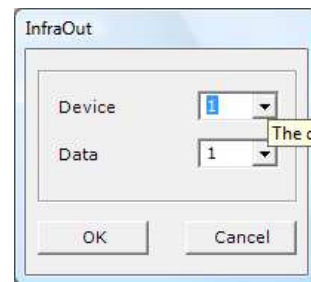

The InfraOut command can be used to transmit any of the valid TV commands (0-127). Note that the Sony protocol only uses 7 bits for data, and so data of value 128 to 255 is not valid.

Using ultrasonic measurement

Ultra

Ultra 0,0,A

The Ultra command is use to detect an object using the SRF005 ultrasonic sensor.

When the output and input pins area assigned to the sensor position the command returns the distance to an object (cm) and assigns this value to a variable.

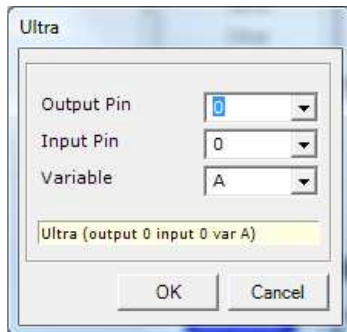

4. Procedures

Logicator software provides a clear, step-by-step method of building a complex control system, by creating a number of linked subsystems called “procedures”. Note that 'Return' was previously known as 'End' and so now use 'Return' instead of 'End'.

How to build a procedure



Use a Procedure command to begin the procedure. Drag the command onto the flowsheet and place it separately from the START command as shown below. Double click on the command to open its Cell Details box. Type in any appropriate name, and click OK. The software automatically puts the name into capitals.

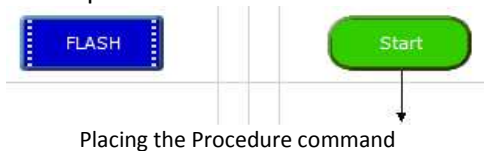

Placing the Procedure command

Use other commands as normal to create the procedure.

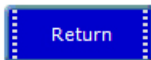

Place a RETURN command at the end of the procedure as shown in the flowsheet below. This command does not have a Cell Details box; simply place it on the flowsheet.

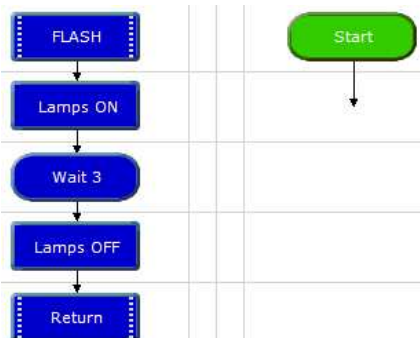

This procedure, called FLASH will switch on selected lamps for 3 seconds and then switch them off

When you have created a procedure, you can test run it. Click on the Procedure command to select it, and click System>Run

How to use a procedure

Once you have built a procedure, you can call it into use whenever you like in the flowsheet by using the Do Procedure command, as shown below.

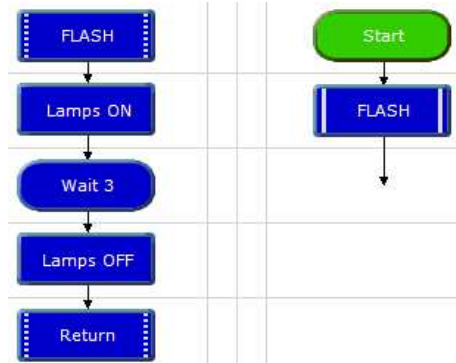

The Do Procedure command calls the procedure into use.

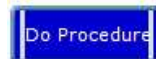

Drag a Do Procedure command onto the flowsheet. Place it at the point where you want the procedure to be called into use. Double click on the command to open its Cell Details box. Type in the name of the procedure or select it from the drop-down list. Click OK.

Note that all the procedures that have been built in a flowsheet are automatically listed in the drop-down box. When flow reaches a Do Procedure command, it jumps to the Procedure command with the same name. When the flow of control reaches a Return command, the flow jumps back to the Do Procedure command that called the procedure. To test run the whole flowsheet, click on the START command to highlight it, and click System>Run

In the cell details box for the Do Procedure command it is also possible to set the number of times to run the Procedure. This will simply repeat the Do Procedure for the set number and then continue as normal.

Example

A PIC microcontroller is used to control a system in a child's toy which plays a tune when it is hugged. A piezo transducer is connected to an output pin, and a push switch is used to sense when the toy is hugged. The flowsheet for the system is shown below. The tune is created as a procedure which can be tested and edited separately from the main routine.

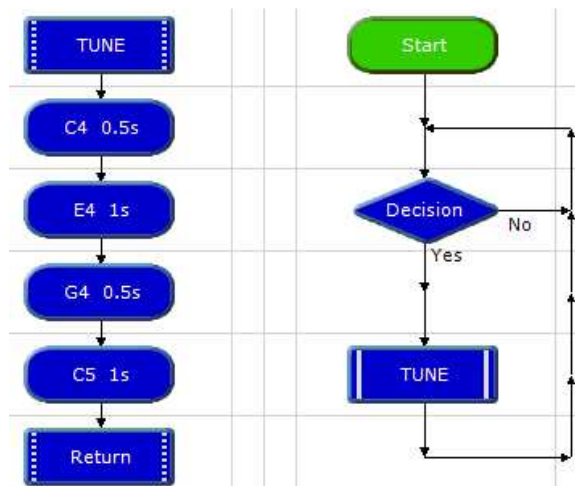
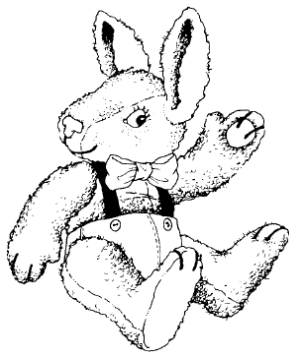

Using a Procedure to play a tune after an input condition is met

Example

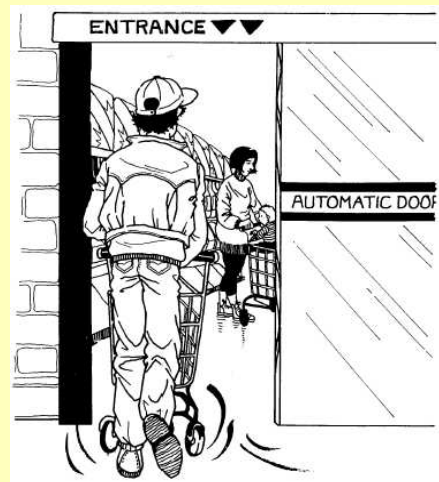

The flowsheet shown below is a control system for a sliding door. When a switch is pressed, the door opens. It stays open for ten seconds and then closes again. The system uses limit switches to sense when the door is fully open and fully closed. The motor is halted in response to the feedback from these microswitches.

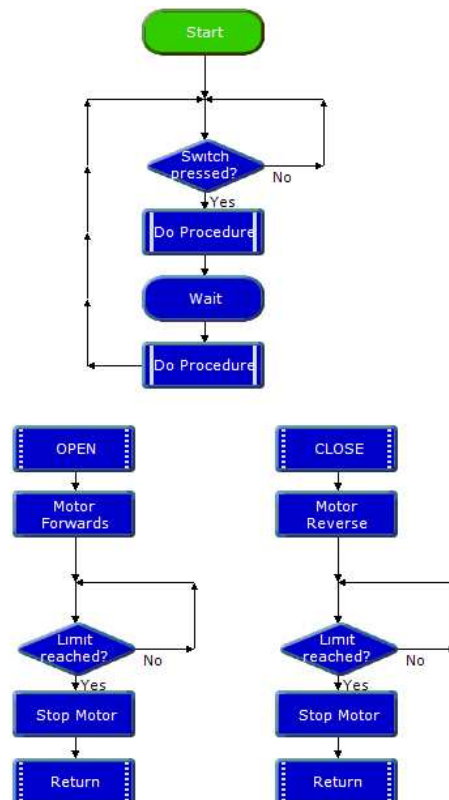

Sliding door control system using procedures

Example

A keypad is a useful input device. This example shows how the Logicator software can be used to scan a keypad in a project in which a three digit number has to be entered to open a solenoid-operated lock.

Connect the keypad to a PIC microcontroller using inputs and outputs as shown right. The flowsheet below shows how the scanning is done.

In this case, the code number uses a digit from each one of the first three rows (e.g. 357 or 268). Each row is scanned in turn using a procedure.

To begin with, the row is made “live” by switching on the output to which it is connected. Then a Decision command checks for the appropriate key in that row to be pressed, by testing for that input to be on. When the correct key is pressed, flow passes on to the next procedure.

When all three digits have been entered correctly, the solenoid is switched to unlock the door.

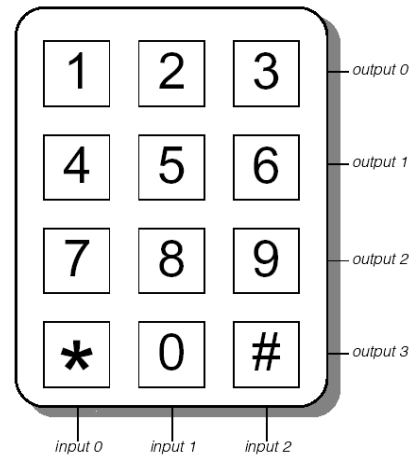

Keypad connections

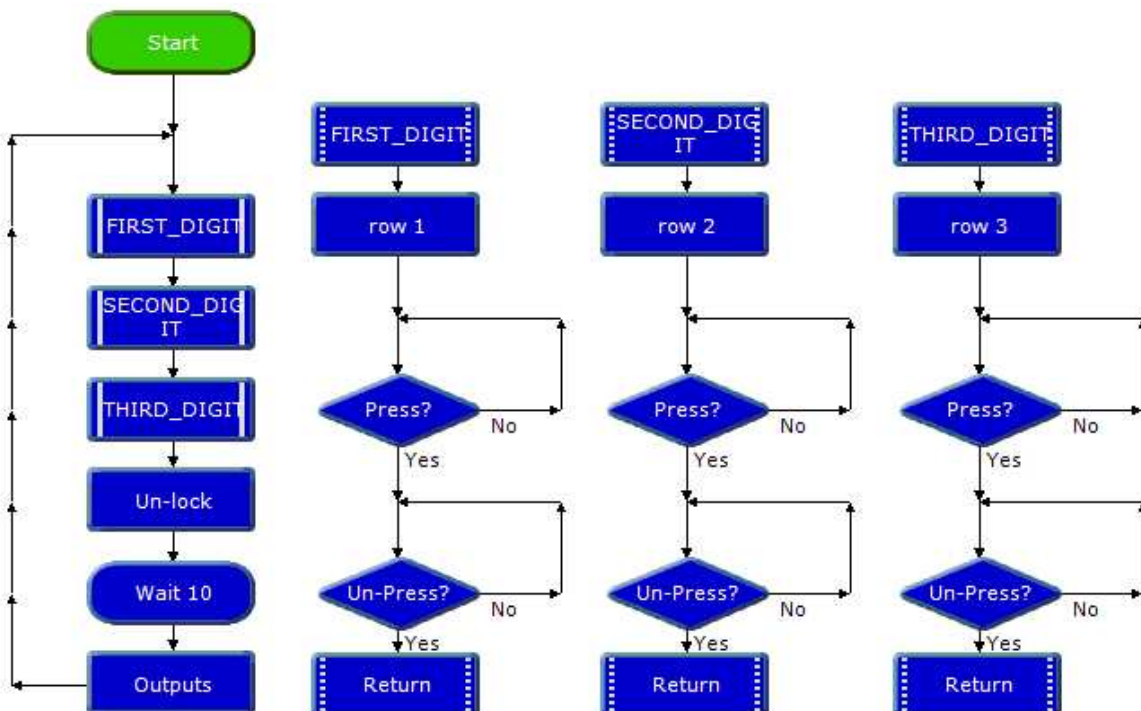

A Flowsheet to scan the keypad

Designing systems with procedures

Using procedures, you can design and test systems either “top-down” or “bottom-up”.

Example

The ‘top-down’ approach

This approach begins with an overall view of the system (the main routine), and then creates each part of it separately as a procedure. The following sequence shows how it can be used to develop a control system for a buggy which is fitted with micro-switches that are pressed if the buggy comes into contact with an obstacle.

When this happens, the buggy sounds an alarm and moves round the obstacle.

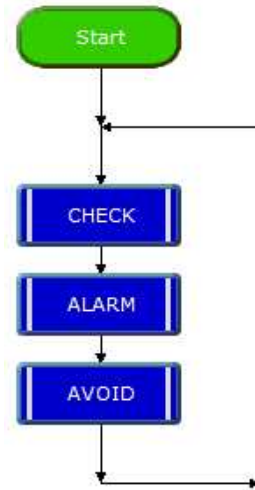

Main Routine

1. The main routine is created as a series of Do Procedure commands as shown right.

2. Then each part of the system is built as a separate procedure as shown below. Each procedure can be test run independently.

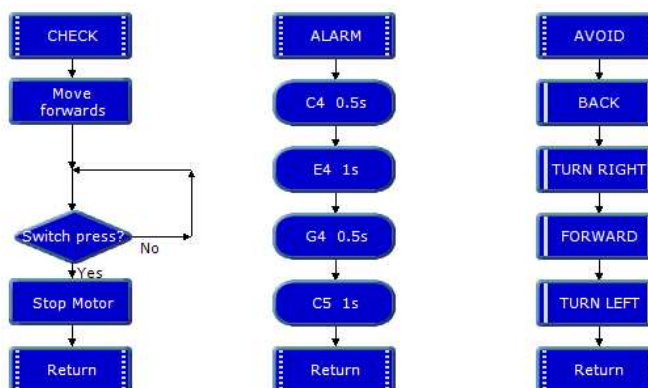
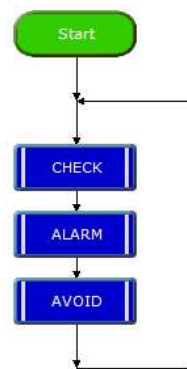

Notice that the AVOID procedure uses the top-down approach, so the flowsheet is incomplete at this stage.

3. The AVOID procedure shown below has been built by using the top-down approach. To clarify the avoiding procedure, each movement is simply listed as a Do Procedure command. Then the details required for the buggy to make each movement can be dealt with separately as shown below.

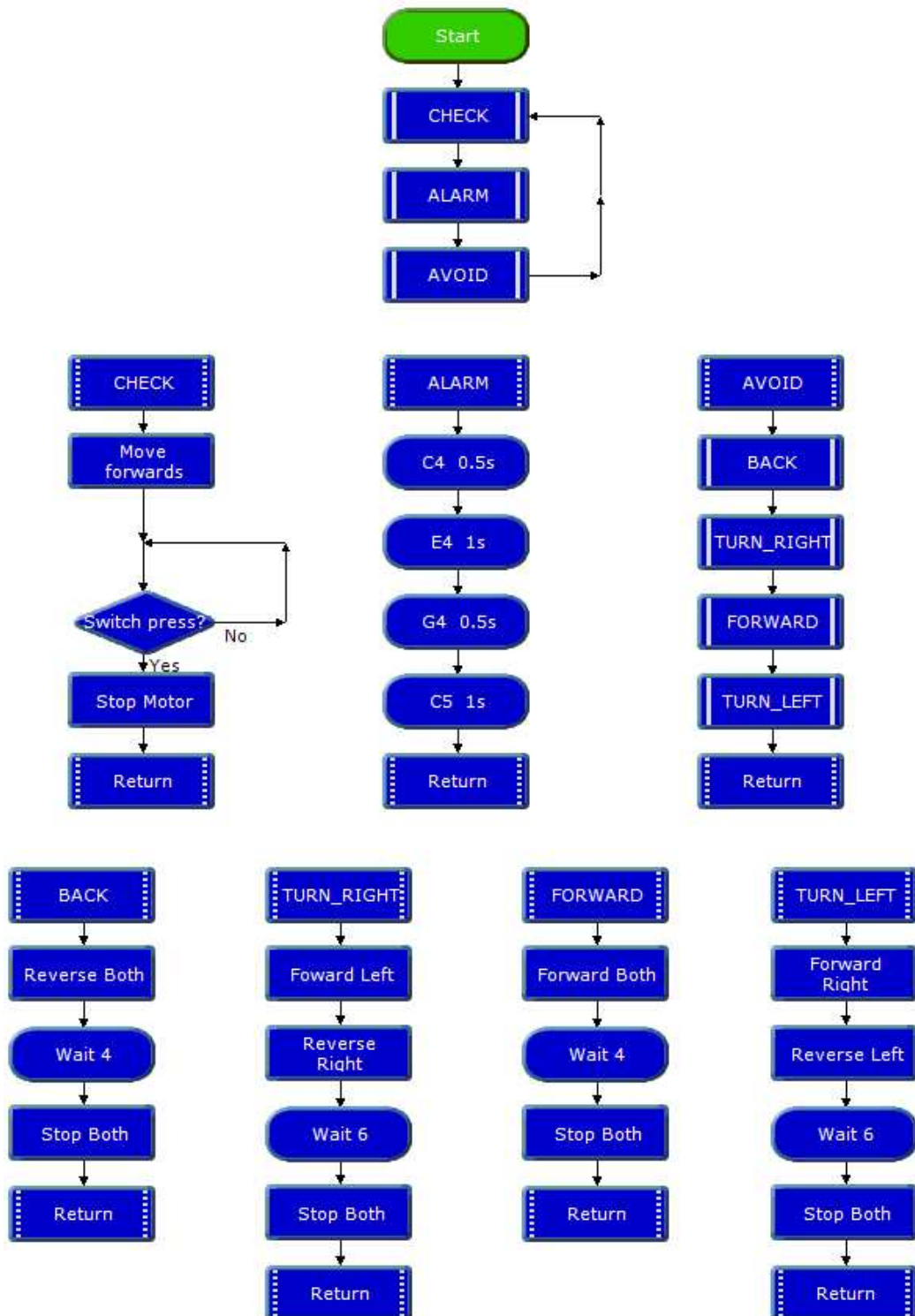
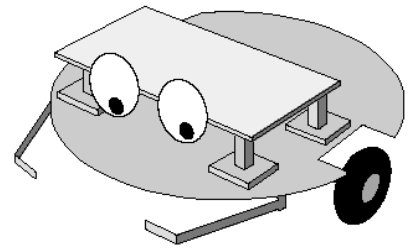

This flowsheet illustrates the way in which procedures may be called from within other procedure definitions.

Example

The 'bottom-up' approach

This approach develops each part of the system separately as a procedure, and then writes the main routine to link them. The following sequence shows how it can be used to develop a control system for an animated clown's head on which the eyes and nose light up and the hat rotates.

1. A separate procedure is built and tested for each one of the three elements, as shown below:

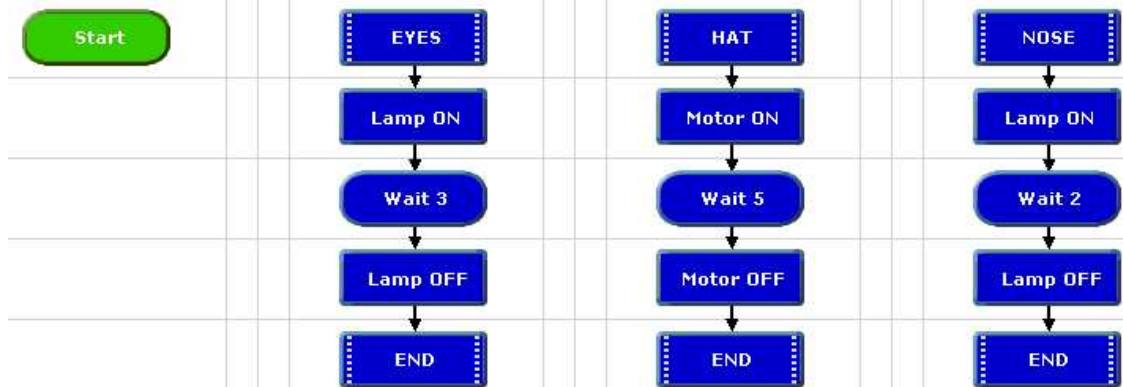

In this approach, the procedures are created first

2. A main routine is then written to call the procedures into use in the required sequence whenever a switch is pressed.



The complete system

This flowsheet shows some of the advantages of using this approach. Once a procedure has been created, it can be called into use as many times as you like within the flowsheet. Editing the sequence is easy.

The Do Procedure commands can be moved around, deleted or copied to change the sequence as required. Procedures can be cut, copied and pasted between flowsheets. Remember that copied commands will retain their existing cell details.

5. Variables

In Logicator a variable is a single letter or a keyword that can be given a value. The variables that can be used are: any one of the single letters A to H. This section explains how they can be used for a variety of mainly counting and timing purposes.

Counting

The Inc command



Each time flow passes through an Inc command, 1 is added to the value of the selected variable (Inc is short for increment). This is the same as using an Expression command to make $A = A + 1$.

When you open the Cell Details box, simply select which variable you want to use, and click OK.

The flowsheet shown below shows how it can be used to repeat a sequence three times. Each time that flow goes round the loop, the FLASH procedure is undertaken, and 1 is added to the value of variable A.

A Compare is used to check the value of A. When this value reaches 3, flow will go in the Yes direction and stop the flowsheet.

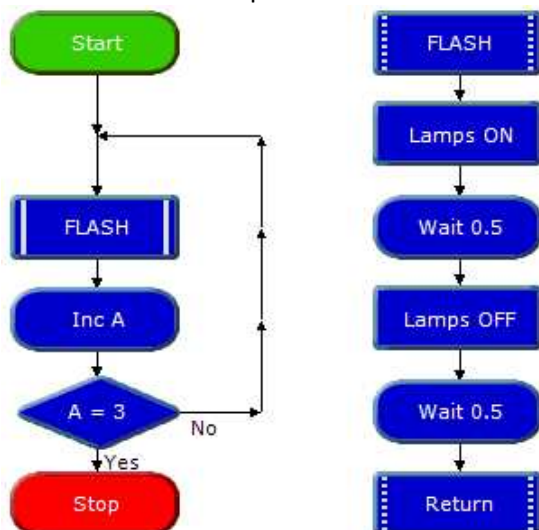

Repeating a sequence three times

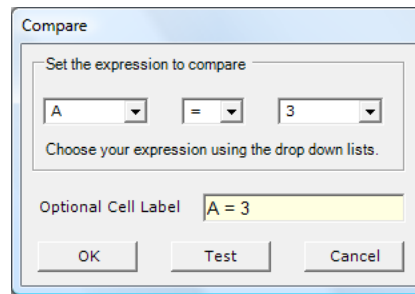

Cell Details box of the Compare command

1. Use box one to select the variable that you want the command to check.
2. Use boxes two and three to complete the comparison. The drop-down list in box two contains a list of operators such as “greater than” (>), “less than” (<), and “equals” (=). Select the one that you require.
3. Use box three to set the number of times the sequence will repeat. Type in a number between 0 and 255, or select it from the dropdown list.

Another use of the Inc command is to count the number of times something happens – the number of people passing through a gate or turnstile for example. This is often done by using a digital sensor such as a micro switch or a reed switch placed so that the sensor is “on” when a person passes. The flowsheet below shows the three commands needed to do this. Notice that two Decision commands are used to check the switch. The first command responds when the sensor is on. Then the sensor is immediately checked again to see that it is off before anything else happens. This ensures a clean signal for the Inc command to count.

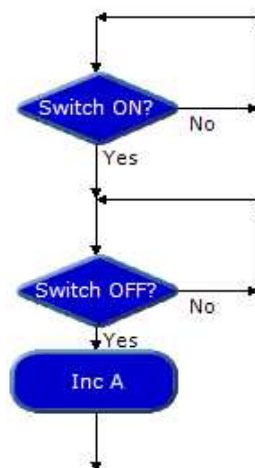

Ensuring a clean signal from a digital sensor

You may well find that once it is downloaded into the chip, the flowsheet runs so quickly that even using the two Decision commands does not give a clean count. If this is the case, you should include a short Wait before the Inc command, as shown in the flowsheet on the right. This flowsheet is for a system to count the number of people passing through a turnstile and to display the number in binary form, using LEDs connected to each one of the eight outputs on a PIC microcontroller.

Example

A PIC microcontroller is used to control a system for counting cars entering and leaving a car park using two digital sensors. The outputs of the system are a red lamp lighting. The flowsheet for the system is shown below. When you run this flowsheet, display the Variables window to see the value of A change.

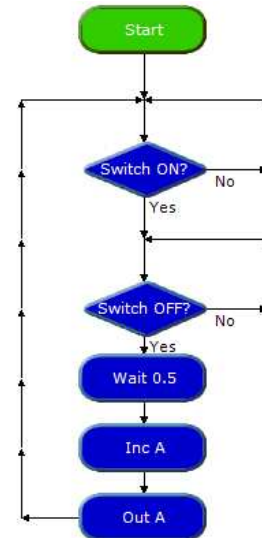

Flowsheet for making and displaying a count.

The DEC command



This system uses the Dec command which works in a very similar way to the Inc command. The difference is that when flow passes

through a Dec command, one is subtracted from the selected variable.

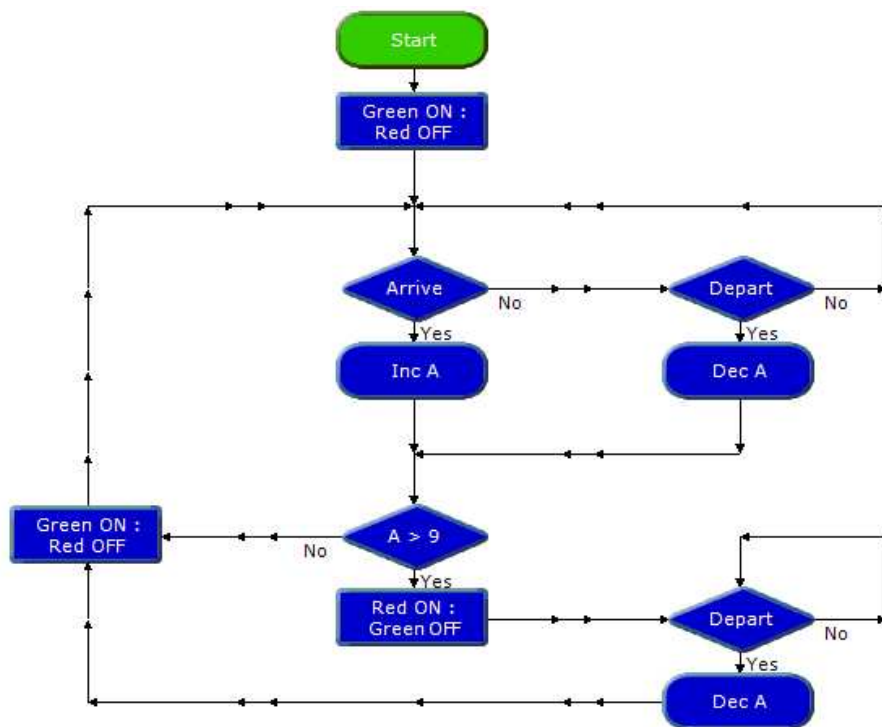

Car Park Counting System

Example

A seven-segment display is a useful output device for displaying counting and timing. The flowsheet below is designed to control the kind of supermarket delicatessen counter system in which customers take a ticket and then wait for their turn to be served when their number is displayed. When the assistant has served a customer, he or she presses a switch to display the next number.

The main routine uses an Inc command to increment (add one to) the value of the variable A each time the assistant presses the switch. The DISPLAY procedure makes an efficient way of translating the current value of A into an Outputs command which is set to switch on the appropriate number of outputs to display the number.

A similar approach could be used with an LCD screen. In this case, the DISPLAY procedure would use a series of SerOut commands as shown below:

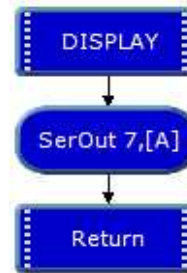

Part of an equivalent system that uses an LCD screen to display numbers.

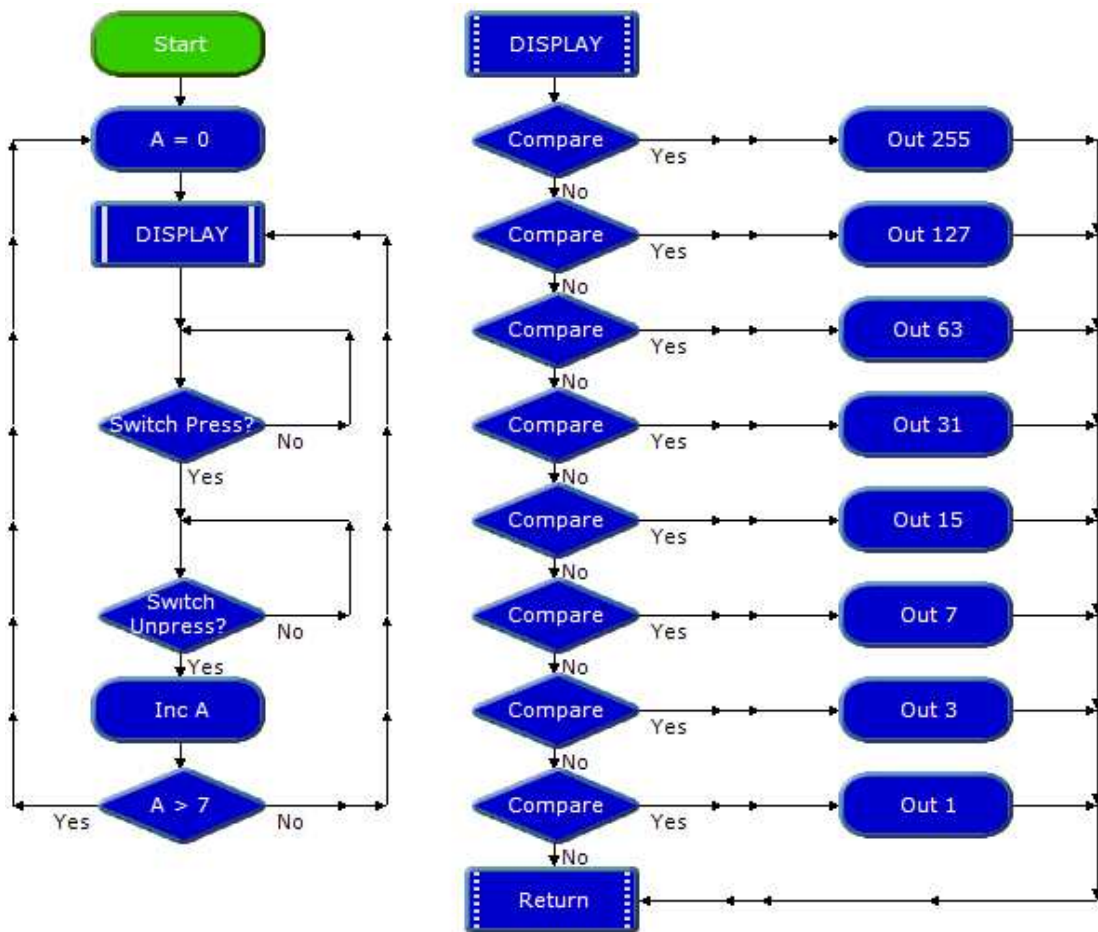

A "Now Serving..." display system.

Timing

To repeat a sequence for a period of time, the Inc command can be used to count the elapsed time. The flowsheet shown below shows how it can be used to repeat a sequence for 10 seconds.

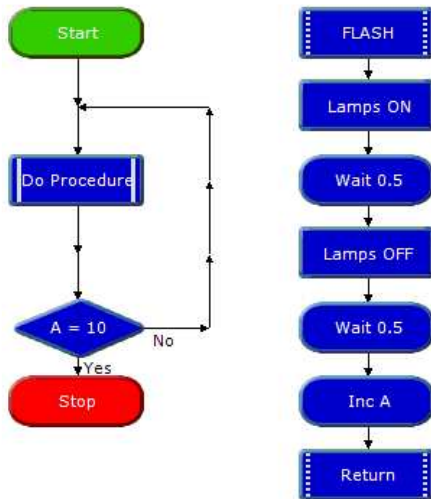

Repeating a sequence for 10 seconds

A Compare is used to check the value of Variable A. When this value reaches 10, flow will go in the Yes direction and stop the flowsheet. Since we know that the FLASH Procedure will take 1 second to complete, repeating this for 10 times will take 10 seconds.

Setting the value of a variable

The Expression command



The Expression command is used to give a value to a variable as a flowsheet runs. The variable is given its value as flow passes through the command. The following example shows how it can be used.

Example

A container in a warehouse is designed to hold ten packs of components. A system is needed to indicate the changing contents of the container as packs are removed. The next flowsheet is designed to do this.

A digital sensor is used to indicate each time a pack is removed (notice the use of two Decision commands to ensure a clean count). The number of packs in the container is displayed as a binary count using 8 LEDs connected to outputs of the PIC microcontroller.

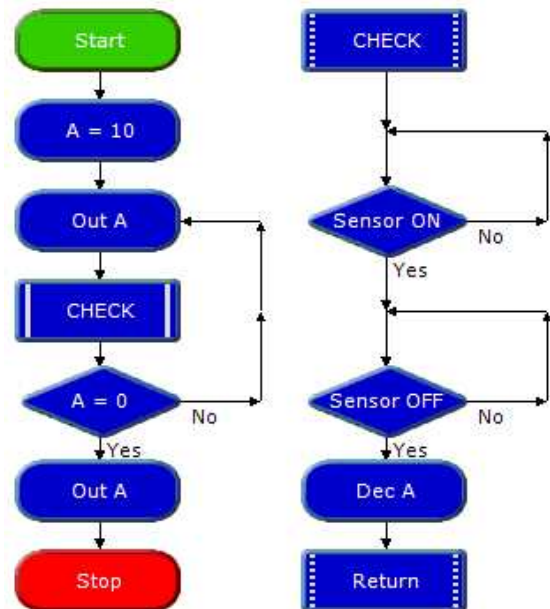

Counting Down

The Dec command counts down, so an Expression command is used to set the value of variable A to 10 at the start of the countdown when the container is full. The Expression command Cell Details box is shown below. Use the first two boxes to enter the expression A = 10.

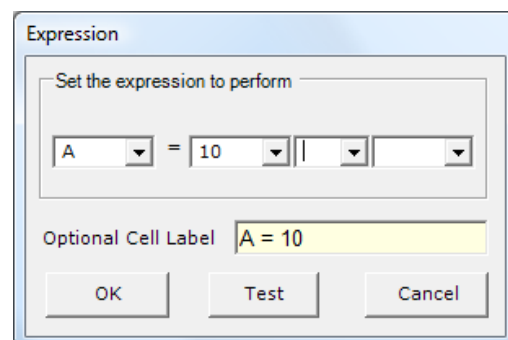

Expression command : Setting the value of a variable

Mathematical expressions

A value can also be given to a variable in the form of a mathematical expression as shown in the flowsheet below. This system counts the number of times that two separate switches are pressed, and displays the combined total. Use all four boxes in the Expression Cell Details box to enter the 39 expression $C=A + B$. NOTE: the third box in the Expression Cell Details box contains a range of mathematical operators.

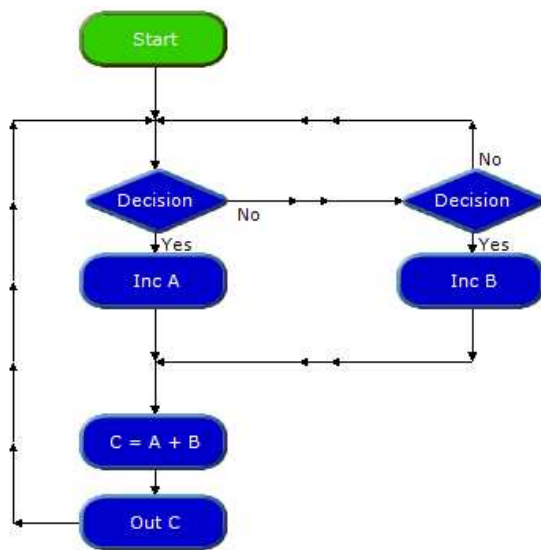

Displaying a combined count

The IN command

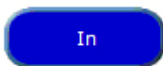

The IN command sets the value of a specified variable to the current binary value

of the input port.

For example, if switches connected to inputs 0 and 1 are pressed, then the value of the variable will be 3. The next flowsheet shows how this can be used to make a simple security system.



When switches connected to inputs 0 and 2 are pressed at the same time the binary value of the input port equals 5 (4+1), flow from the Decision command goes in the Yes direction and a solenoid-operated lock is opened. If any other combination of switches is pressed, flow goes in the No direction.

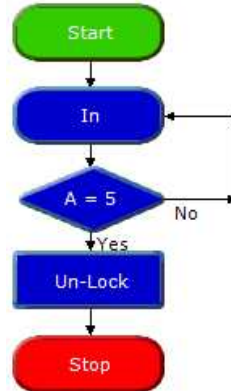

Security system that responds to pressing two switches

The RND expression

Using the expression $A = \text{RND}$ command a Variable can be given a random value between 0 and 255. In the example shown below, a set of display lights for a small Christmas tree are connected to 8 outputs of a PIC microcontroller. Every second the display will change at random.

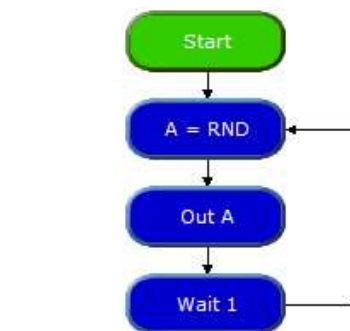

Using RND to create a random display of lights

Note that as with all microcontrollers and computers, the generation of random numbers is based on a set sequence.



Another way to create a random value to a variable is to use the Random command.

READ and WRITE



When a flowsheet run is started, all variable values automatically reset to zero. So, when the PIC microcontroller is reset or powered up, all variable values are reset to zero.

If you want to retain variable values when the PIC microcontroller is powered up or reset, you can use the WRITE command to store values in the chip's EEPROM memory. The READ command is used to retrieve the values from the chip's memory. The flowsheet below right shows an example of how the commands can be used. The following information explains how this works.

The READ command takes the value which is currently stored in a selected address (in this case address 0), and puts it into the selected variable (in this case variable A). Use the READ command Cell Details box (below) to enter the variable and the address from which the value is to be read.

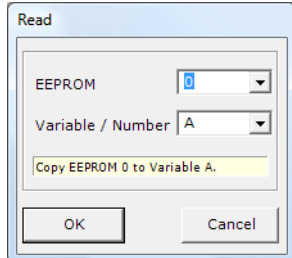

READ command Cell Details box

The PIC microcontroller's EEPROM memory has 16 separate addresses. Each one can store a number between 0 and 255. The EEPROM window displays the contents of the memory when you test run a flowsheet.

EEPROM			
00	0	08	0
01	0	09	0
02	0	10	0
03	0	11	0
04	0	12	0
05	0	13	0
06	0	14	0
07	0	15	0

EEPROM window

The OUT A command in the flowsheet displays the current value of A using 8 LEDs connected to outputs of the PIC microcontroller.

The Inc A command increments (adds one to) the value of A each time a switch is pressed. The new value of A is immediately stored in address 0 of the EEPROM memory by the WRITE command. The Cell Details box of this command is used in the same way as for the READ command.

When the PIC microcontroller is powered down, the value of A is stored in the chip's memory.

When the PIC microcontroller is powered up, the first thing that happens is that the READ A,0 command retrieves the value of A which has been stored in address 0. The EEPROM window gives an accurate simulation of the way these commands work when the flowsheet is downloaded.

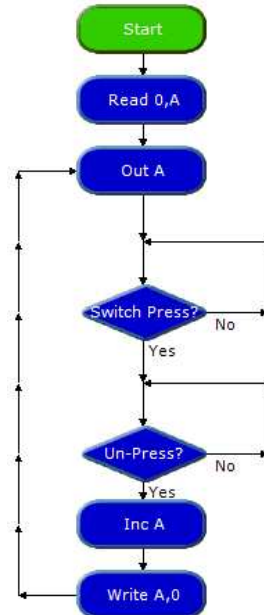

Using READ and WRITE commands to store a count

This flowsheet shows how the Read and Write commands are used to store the number of times a switch is pressed.

Time



The PICAXE 28X1 chip has an internal clock module. The Time On command starts the clock cycle. The Time Off command will stop the clock. The elapsed time will be measured in seconds by the variable 'Time'.

The flowsheet below will measure the elapsed time until a button is pressed. The Time can be viewed in the Time panel and in this case its value is stored in the variable A.

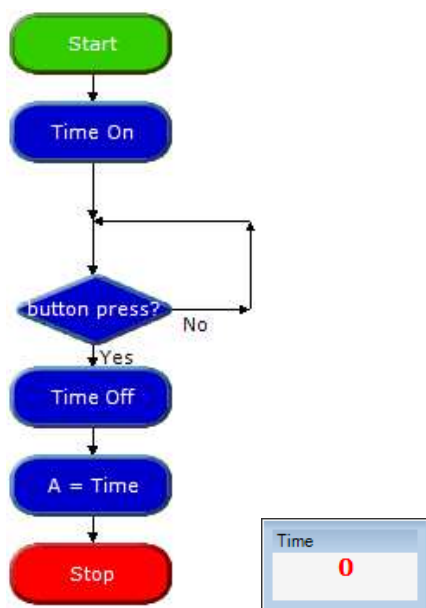

LCD



This command can be used to display a message on an LCD screen attached to a PICAXE-driven circuit board.

In the cell details window a message can be written over two lines if required and an output pin is assigned.

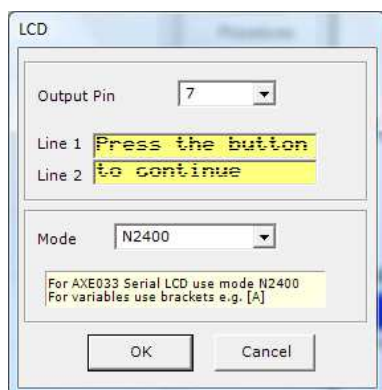

This command will be simulated if the flowsheet is run from Simulate > Run. A small window will pop up during the run to display the LCD message. The window can be enabled by choosing View > LCD panel

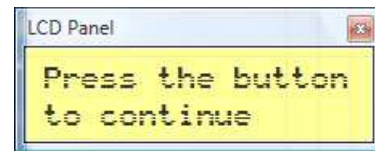

a simulated LCD screen

BASIC



This command is used as an extension to a flowchart.

PICAXE BASIC code can be typed into the command cell window. When program flow arrives at this command the BASIC code within the command will be interpreted as if it were a procedure.

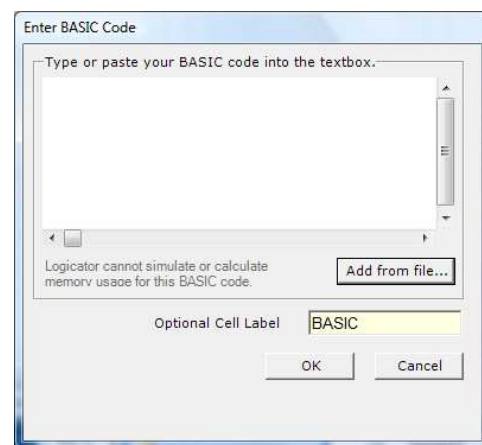

RANDOM



This command can be used to generate a pseudo random number and assign it to a variable.

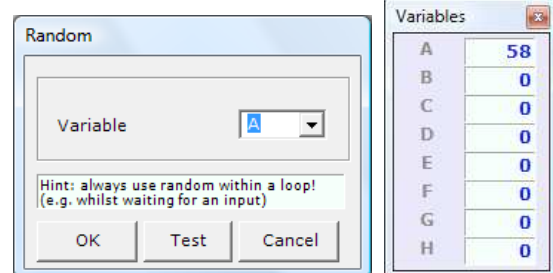

The Random dialogue window

For greater randomness, use the command in a loop terminated by a switch press.

Simulations

Logicator will support the use of simulations of PIC circuits. These simulations are called Soft Systems.

On the CD supplied with the software are a number of simulations. Soft Systems are accessed from the Simulate menu.

An example follows:



The Rudolph Soft System

A Helper screen can be opened from the Simulation Help menu. This tells us which PICAXE chip the circuit is simulating and how the inputs and outputs are connected.

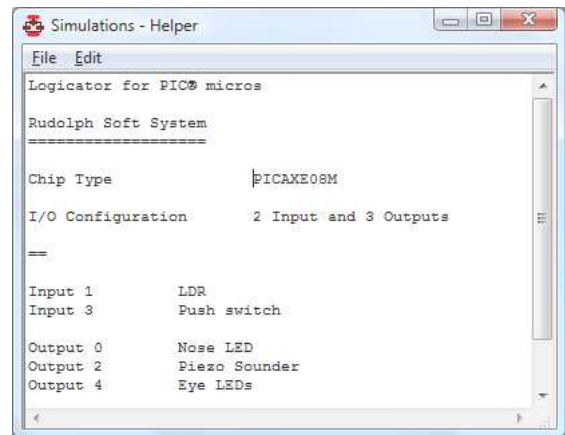

The Rudolph helper window

The simulation can be manipulated as though it were a real circuit board:

- The battery terminal can be clicked to plug and unplug the battery connections.
- The USB lead can be clicked to connect and disconnect it.
- The inputs can be clicked to generate a simulated input.

With this information, the student can now program and test the simulation as though it was a real system.

This simulation is also available as a real circuit board. In practice, students can work on either the real circuit board or the simulation with equal effect.

Further Soft Systems can be created using the Soft Systems editor.

